



Killgerm®

You know when
you're in safe hands!

www.killgerm.com



Focus on your
future



Scan Me for all
the latest news
at Killgerm®



Killgerm®

You know when
you're in safe hands!

www.killgerm.com

Focus on your future

We welcome 2023 with open arms and
this year we are focussed more than ever on you!

2023

All the pieces of our business are built with you in mind. We work hard to make sure that every service we offer to you, is what you need for your future. Our customer services team are here to help you with enquires, issues and advice. The technical team is bursting with knowledge and experience to guide you through the daily puzzles you come across, as well as our team of highly qualified area sales managers at the end of a call or on your doorstep. 2023 is our focus and we intend to reflect our strengths on you and your future, and Killgerm has the tools and experience to help you along the way. Along with our service offering, we have more fun campaigns we would like you to be a part of this year...

Reflect on your day with us. We are always eager to know your thoughts, so please let us know how you think we are doing. As well as only being a phone call away, there will be many opportunities to speak to us and reflect on your day and your Killgerm experiences - the positives and the opportunities! You ask and we listen.

What's puzzling you in 2023? We would love to see pictures from your day, and the interesting pests you find. Send them in and we will share!

Let us focus on **YOU**.

Don't forget to look out for our recycled products!



Contents

CONTENTS

New Products	// 4-5
Killgerm Training	// 6-7
Insect Control	// 8-43
Application & Equipment	// 44-59
Health & Safety	// 60-67
Tools & Accessories	// 68-75
Rodent Control	// 72-115
Bird Control	// 116-146
Cleaning & Hygiene Products	// 147-149
Information & Guidance	// 150-164

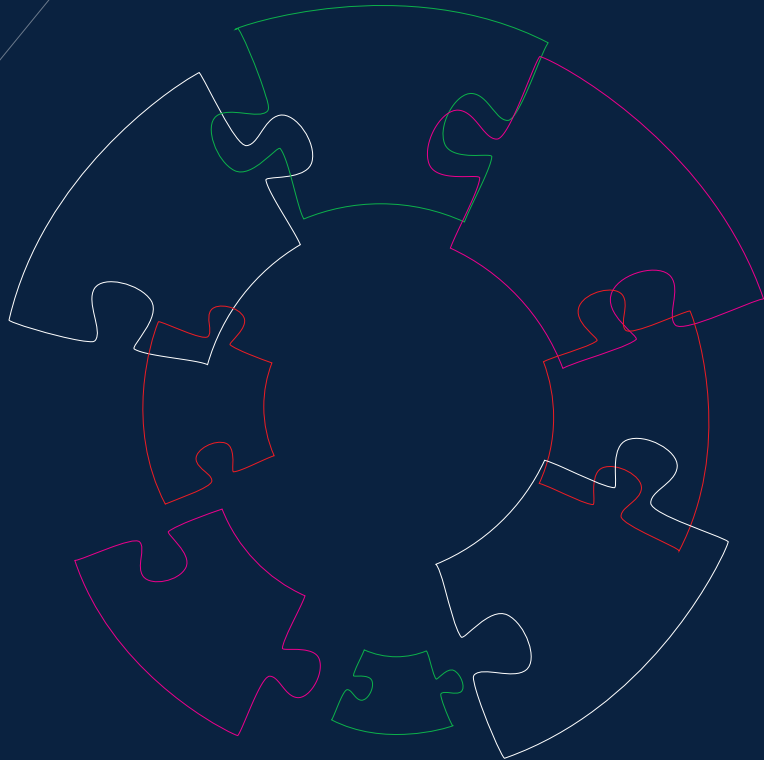

A circular arrangement of interlocking puzzle pieces in various colors (green, red, white) surrounding a central green dot.

Product Development

Our Product Development team globally source and develop innovative and creative solutions for the professional pest control industry. They test and evaluate all aspects of new products to ensure they meet your needs. We are here to make sure the products we develop make a difference to you and your business. You ask, we listen.

Industry Support

Through strong support of industry initiatives, such as CRRU, RAMPS, NPAP (National Pest Advisory Panel), Basis Prompt and Government bodies, we are constantly striving to maintain the portfolio of products for professional pest controllers to carry out their day to day role. Killgerm can see the industry clearly and understands your needs. We are proud to take the lead on various panels to ensure you have a voice.

Professionally trained Sales & Customer Service Teams

At the core of our business is excellent support through our Area Sales Managers and expertly trained RSPH qualified Customer Service Team. This means we can provide your business with a countrywide service at a local and personal level.

Technical Department & Training

Killgerm has the UK's largest Technical Department in the industry to serve you with independent and unbiased advice on product selection. This great service helps you to solve technical problems and receive unrivalled professional training.

Breakfast Meetings & Workshops

Our breakfast meetings and workshops run throughout the country, giving you the opportunity to meet with industry experts, and the Killgerm team so you can develop your professional skills and abilities. We are here to develop your skills as a pest controller.

Logistics & Delivery

We aim to power your business needs by making sure you get your delivery when you need it.

A circular arrangement of interlocking puzzle pieces in various colors (green, red, white) surrounding a central green dot.

NEW PRODUCTS 2023

Please contact the Killgerm® Customer Service Team or your local Area Sales Manager if you would like any product demonstrations.

NEW



PULSE MOUSE
PAGE 82

NEW



RAT IQ STATIONS
PAGE 93

NEW



T-REX IQ TRAP
PAGE 96

NEW

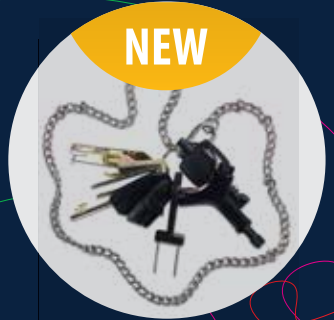

BAIT BOX KEY SET
PAGE 94

NEW



AIROFOG U240
PAGE 48

NEW



AIROFOG U260
PAGE 48

NEW



AIROSTAR
PAGE 48



DOCTRAP
PAGE 96



DOCTUNNEL
PAGE 96



CHAMELEON QUALIS ST/ST
PAGE 38



SIRIUS X
PAGE 38



**SUPER CAM
INSPECTION CAMERA**
PAGE 64



SAKARAT RODENT LURES
PAGE 84



STIXX SOLAR FLEX 160CM
PAGE 136



Killgerm[®]
TRAINING

Killgerm[®]
TRAINING
 Delivering High Quality Training

Weapons Rabbits Vertebrates Grey Squirrel Legislation & Safety Cockroaches

TRAINING MANUAL

Control Flying Insect Control Pest Birds Entomology Practical Drainage Investigation

DELIVERING HIGH QUALITY TRAINING

Killgerm[®]
TRAINING

This is to certify that

AN Other

Has successfully completed the
Training Course

KILLGERM TRAINING

KILLGERM CHEMICALS LIMITED
 PO Box 2, Clifton, West Yorkshire, WF5 9VA
 TELEPHONE: 01924 268 445 EMAIL: training@killgerm.com
 www.killgerm.com

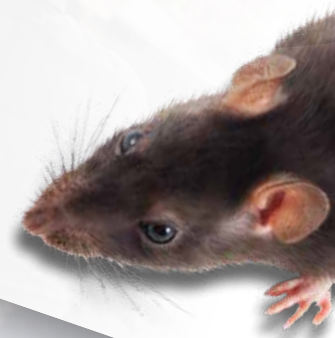

TRAINING COURSES

Killgerm Chemicals can assist with training requirements and we can offer a variety of courses to those requiring certification for undertaking public health pest control.

While there are many schemes on offer, our training can be brought to you. If you have a suitable facility and can provide refreshments, training can be booked quickly and simply by contacting training@killgerm.com.

As an example, our principles of rodent control course can be delivered in just one day with an online exam to follow at a later convenient date. Or, if you prefer, training can also be delivered at our HQ in Ossett.

Also on hand is the Killgerm Training Manual, an essential guide to pest control. It is packed with all of the information you need to run a pest control operation.

For more information please call: **01924 268445**
or email: **training@killgerm.com**

KILLGERM TRAINING MANUAL

KILLMANU4	Each
-----------	------

Online training courses available at www.killgerm.com

Due to evolving government advice, some of our face-to-face training courses may be postponed. You can visit <https://training.killgerm.com> to view our alternative online options and check the training website for updates <https://www.killgerm.com/technical>



KEY TO ENTRIES IN THE INSECTICIDE AND RODENTICIDE SECTIONS

A

B

C

D

E

F

B VAZOR® PHEPRA | HSE XXX

PROFESSIONAL

NC

Vazor® Phepra CS contains 1R-trans Phenothrin 10% w/w (100 g/l), Prallethrin 1% w/w (10 g/l)

Dilution rate:

A microencapsulated insecticide in aqueous suspension, for professional use, with rapid knockdown and residual effect of 12 weeks on non-porous and porous surfaces. A non-staining, water-based surface spray, of neutral odour. For the control of crawling and flying insect pests for spray application indoors, e.g. in homes, warehouses, animal shelters, industrial plants, public buildings and spaces including food handling and storage areas as well as hospitals. Can be used in agricultural premises, stables, chicken and poultry farming, livestock units, empty grain storages, farm outbuildings and dairies. Effective against a broad spectrum of insect pests including ants, bed bugs, German and Oriental cockroaches, litter beetles, poultry red mites, flies such as house fly, stable fly and horn fly, mosquitoes, food moths, wasps and European hornet



VAZORPHEPRA001L

1 x 1 litre

J

I

H

G

A Product name

B Approval number

C Active ingredients

D Approval categories:

Non-Professional/
Amateur use - Means that the product can only be used in a non-professional capacity. Specific training is not required to purchase and use non-professional products.

Professional use - Means that the product can only be used by people who are required to use pesticides as a part of their work and who have received appropriate information, instruction and training.

E Dilution rates

F Pesticide Group

SP Synthetic Pyrethroid

C Carbamate

NC Novel Compound

Bio Biological Agent

IN Inorganic

NP Natural Pyrethrin

G Single unit price

H Product description

I Product code

J PPE pictograms



PROTECTIVE CLOTHING

PROTECTIVE GLOVES

GAS MASK

PROTECTIVE GOGGLES



Please Note

All information given in these entries is prepared to the best of our knowledge and ability and is given in good faith, but we cannot accept any responsibility for loss or damage arising from any error or omission. The PPE pictograms are provided as a guide only and should in no way replace any part of your COSHH assessment. Certain conditions may require additional PPE. For full details of the ingredients, approval, hazards, application and precautions for any pesticide product, consult the product label and safety data sheet before use. Advice is also available from Killgerm's Technical Department.

- B - Bees Only
- W - Wasps Only
- A - Ants Only
- M - Mites Only
- S - Spiders Only
- Mq - Mosquitoes Only
- T - Ticks Only
- ✓ - For use on all listed

Acarina : Mites/Ticks/Spiders	Coleoptera : Beetles	Hymenoptera : Bees/Wasps/Ants	Siphonaptera : Fleas	Diptera : True (Two-winged) Flies	Lepidoptera : Moths	Hemiptera : Bugs	Psocoptera : Booklice	Blattodea : Cockroaches	Dermaptera : Earwigs	Orthoptera : Crickets/Grasshoppers	Thysanura : Silverfish/Bristleails
-------------------------------	----------------------	-------------------------------	----------------------	-----------------------------------	---------------------	------------------	-----------------------	-------------------------	----------------------	------------------------------------	------------------------------------

AEROSOLS

SP	Bayer Flying Insect Killer	✓	W/A	✓	✓	✓	✓	✓	✓	✓	✓	✓
SP	Vazor Wasp Nest Destroyer Foam Aerosol		W									
SP	Vazor Ice	✓	W/A			✓	✓	✓	✓			
SP	Digrain Control		W/A	✓	✓	✓			✓			
SP	Phobi F&F One Shot		W/A	✓	✓	✓			✓			
SP	Digrain Wasp Nest Destroyer		W			✓	✓					

COARSE SPRAYS

SP	K-Obiol EC25		✓				✓					
NP	Aquapy		✓	W	✓	✓	✓		✓			
SP	K-Othrine® Partix	S	✓	W/A	✓	✓	✓	✓	✓	✓	✓	✓
SP	Deadline Insectaban Liquid		✓	W	✓	✓	✓	✓				
NP	Deadline Pyspray		✓	W/A	✓	✓	✓	✓	✓			
SP	Phobi Dose						✓		✓			
SP	Vazor® Provecta	✓	✓	W/A	✓	✓	✓	✓	✓			
SP	Harmonix® Poultry Red Mite	M										

DUSTS

C	Ficam D			W/A								
NP	Deadline Pydust	S	✓	W/A	✓		✓		✓			✓
SP	Nippon Ant Killer Powder		✓	W/A					✓	✓		✓
IN	Vazor® DE Powder	✓	✓	A	✓		✓	✓	✓	✓		✓

NOVEL INSECTICIDES

NC	Advion Ant Gel			A								
NC	Outcast Ant			A								
NC	Maxforce Platin								✓			✓
NC	Maxforce Quantum			A								
NC	Nippon Gel			A								
NC	Advion Cockroach Gel								✓			
SP	Cimetrol Super EW		✓	W	✓	✓	✓	✓		✓		

SPACE/CONTACT SPRAYS

NP	Pybuthrin 33		✓	W	✓	✓	✓			✓		
SP	Vazor® ULV 500	✓	✓	W/A	✓	✓	✓	✓	✓	✓		✓
NP	Aquapy		✓	W	✓	✓	✓	✓		✓		
SP	Perbio Choc			W/A	✓	✓	✓	✓		✓		
NP	Deadline Pyfog			W		✓	✓					

INSECTICIDE CONCENTRATES



A



B



C



D

A PHOBI CAPS

PROFESSIONAL

NC

Contains (Cypermethrin 9.2%, Prallethrin 0.46%)

- Micro Encapsulated Liquid Concentrate Insecticide
- Phobi CAPS works in less than 15 minutes and protects treated surfaces for up to 12 weeks.
- Fast knockdown and residual
- Odourless and non-staining
- Active on porous and non-porous surfaces
- Microencapsulation ensures long-term stability of the action against light, temperature and humidity
- Different sized capsules within the active allow for regular and continuous release.



PHOBICAPS

1 x 1 litre

B DIGRAIN CYPERBIO 100EW+

PROFESSIONAL

SP

Contains (9.86% Cypermethrin)

Professional-use Insecticidal Surface Spray. Digrain Cyperbio 100EW+ is a professional-use highly effective broad-spectrum, water-based insecticide with long term residual activity. As an insecticidal surface spray with strong efficacy against flying and crawling insects such as ants, cockroaches, fleas, flies, wasps, and mosquitoes. Designed for use in public health, food storage practice, waste, and sites on surfaces including walls, floors, cracks, and crevices, around machinery or directly on insects. Available Sizes: 1-litre measuring bottle.



DIGRAIN

1 x 300ml

C VAZOR® PHEPRA CS

PROFESSIONAL

NC

Vazor® Phepra CS contains 1R-trans Phenothrin 10% w/w (100 g/l), Prallethrin 1% w/w (10 g/l)

A microencapsulated insecticide in aqueous suspension, for professional use, with rapid knockdown and residual effect of 12 weeks on non-porous and porous surfaces. A non-staining, water-based surface spray, of neutral odour. For the control of crawling and flying insect pests for spray application indoors, e.g. in homes, warehouses, animal shelters, industrial plants, public buildings and spaces including food handling and storage areas as well as hospitals. Can be used in agricultural premises, stables, chicken and poultry farming, livestock units, empty grain storages, farm outbuildings and dairies. Effective against a broad spectrum of insect pests including ants, bed bugs, German and Oriental cockroaches, litter beetles, poultry red mites, flies such as house fly, stable fly and horn fly, mosquitoes, food moths, wasps and European hornet



VAZORPHEPRA001L

1 x 1 litre

D VAZOR® PROVECTA

PROFESSIONAL

SP

Dilution: 100ml/5ltr water

Vazor Provecta is a physical mode of action "sprayable entrapping" formulation for effective control of resistant populations of crawling and flying insects. This concentrate for dilution with water acts by causing external immobilization of target insects. Vazor Provecta is an excellent alternative to traditional insecticides and functions as a resistance management tool due to the physical mode of action. Based on Polyalkyleneoxide modified heptamethyltrisiloxane, Vazor Provecta is recommended to be used for the treatment of resistant populations e.g. bedbugs. It should be applied topically (directly) to insects such as bedbugs, cockroaches, spiders, ants, flies & mosquitoes, stored product insects. Vazor Provecta can be applied as a coarse spray or fine mist.

Benefits include:

- Physical mode of action.
- Product can be used in the presence of stored products.
- No residues, no waiting / withdrawal period.



VAZORPROV001L

1 x 1 litre

VAZORPROV005L

1 x 5 litre

INSECTICIDE CONCENTRATES

SPECIALIST INSECT CONTROL

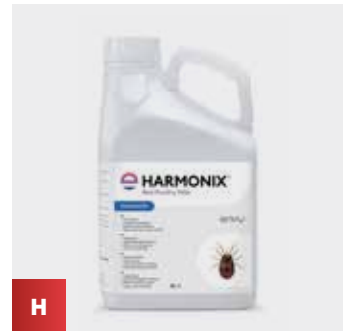

E	K-OTHRINE PARTIX BPR: UK-2018-1166-02	PROFESSIONAL	SP
----------	--	---------------------	-----------

Contains: 2.49% Deltamethrin

Dilution 25ml/5ltr water

A broad-spectrum suspension concentrate for use against a wide range of insects, including: indoor control of crawling insects, cockroaches, bedbugs, houseflies at rest and spiders, plus outdoor control of wasps in free hanging nests.

- Suitable for use in public places such as schools and hospitals, domestic, commercial and industrial premises.
- Features an innovative formulation containing carnauba wax, which holds insecticide onto all surfaces, even absorbent ones.
- The new formulation also enhances bioavailability of the active ingredient, resulting in efficacy even at low application rates.



KOTHPART250ML 1 x 250ml

F	CIMETROL SUPER EW HSE 10078	PROFESSIONAL	SP
----------	--------------------------------------	---------------------	-----------

Contains: 25% cypermethrin, 10% tetramethrin, 20% piperonyl butoxide, 1% pyriproxyfen

Dilution 25ml/5ltr water

Cimetrol Super EW is the next generation of product for the control of insect pests. Formulated as an oil-in-water emulsion containing a very high loading of active ingredient, it allows rapid access of the active ingredient to the insect while providing long-lasting and predictable residual control. Cimetrol Super EW contains a Type I pyrethroid for fast flushing and knockdown, a Type II pyrethroid for rapid kill of the insects, a metabolic synergist to bypass insect metabolic resistances, and an Insect Growth Regulator (IGR), demonstrating a completely different mode of action to ensure that any stubborn populations never get to pass their resistant properties onto the next generation.



CIMETSUP500M 1 x 500ml

G	K-OBIOL EC25 MAPP 13573	PROFESSIONAL	SP
----------	----------------------------------	---------------------	-----------

Contains 25g/L deltamethrin and 225g/L piperonyl butoxide

A Pyrethroid formulation for the control of stored grain product pests. Gives up to 12 months control from one treatment. Approved for fabric of the building and admixture application.



KOBIOL001L 1 x 1 litre

Please note that any operator using this product is required to hold PA1 and PA6 certificates

H	HARMONIX® POULTRY RED MITE	PROFESSIONAL	SP
----------	-----------------------------------	---------------------	-----------

Dilution: 130ml/1ltr water

Exempt from Biocidal Product Registration, Harmonix Poultry Red Mite benefits from a dust penetrating formulation that uses a physical mode of action to control mites, whilst avoiding potential pesticide contamination. Suitable for any stage of the flock cycle, Harmonix Poultry Red Mite contains a food grade cellulose polymer that can be applied while birds are present as a standalone treatment, or as part of an integrated pest management programme. Harmonix Poultry Red Mite can help to reduce skin irritation and stress amongst poultry caused by mite biting, and can be an important tool when preventing the spread of poultry related disease, transmitted via poultry mites.



HARMITE005L 1 x 5 litres

Delivering peace of mind

Provide your customers with the
right pest management solutions

Envu was founded in 2022, a new company built on years of Bayer experience, for the sole purpose of advancing healthy environments for everyone, everywhere.



INSECTICIDE READY-TO-USE POWDERS AND DUSTS

INSECTICIDE ULV FORMULATIONS



A FICAM D™ | BPR: UK-2018-1136 PROFESSIONAL **C**

Contains 1.25% bendiocarb

An odourless dust for the control of a wide range of insects. Superior control against wasps, as does not excite the wasps. Formulation allows high penetration into void areas.



FICDU003K 1 x 3 kilos

B VAZOR® DE POWDER PROFESSIONAL / AMATEUR **NC**

Contains silicon dioxide

VAZOR® DE Powder contains amorphous silica which acts on the outer layer of the cuticle of any insect it contacts. Their outer, protective coating is disrupted and the insect dies.



VAZORDE200G 200g Puffer Pack
VAZORDE002K 2 Kilo Tub

C AF POWDER SCOOP

The AF Powder Scoop has been designed to allow the easy filling of a wide range of dusting equipment. This useful tool, made from polypropylene, helps to reduce the exposure time to insecticidal powders and reduces waste from spilt powder. It can be used as a traditional scoop for larger dusting application equipment or as a combined scoop/funnel for use with smaller powder application tools.

AFPOWSCOOP Each

D AQUAPY™ | HSE 5799 PROFESSIONAL **NC**

Contains Chrysanthemum cinerariaefolium extract 3.0% w/w (30 g/L) synergised with piperonyl butoxide

A water-based product, used as a ready-to-use Ultra Low Volume (ULV) application for fogging, or diluted for misting and surface spraying. A non-persistent, quick knockdown product, suitable for flying and crawling insect control. A 1ltr bottle of Aquapy can treat up to 30,000 cubic metres for flying insect control. Accepted for use in organic areas/sites. Approved for use in empty grain stores.



AQUAPY01L 1 x 1 litre

E VAZOR® ULV 500 | HSE 4647 PROFESSIONAL **SP**

Contains 4.4% phenothrin, 0.8% tetramethrin, 8% synergist

For ULV application. An 'oil-based', ready-to-use, non-persistent, quick knockdown synthetic pyrethroid product, suitable for the control of a number of flying and crawling insects and arachnids. 1 Litre bottles for use with the Exodus machine.



VAZORULV5001L 1 x 1 litre
VAZORULV5005L 1 x 5 litres

INSECTICIDE READY-TO-USE LIQUIDS

INSECTICIDE SMOKES



A



B



C



D

A PYBUTHRIN 33™ | HSE 5106

PROFESSIONAL

NC

Contains 0.38% *Chrysanthemum cinerariaefolium* extract

For fogging or surface spraying. An 'oil-based', ready-to-use, non-persistent, quick knockdown product, suitable for flying and crawling insect control.



PYB33005L

1 x 5 litres

B DEADLINE PYFOG | HSE 10720

PROFESSIONAL

SP

Contains *Chrysanthemum Cinerariaefolium* extract 0.12%, Piperonyl butoxide 0.96%

Water based formulation, specifically designed for use in a thermal fogger. The non-persistent formulation provides quick knockdown. Suitable for use in both domestic and commercial premises, the formulation is ideal when quick knockdown and low residuality is required.



PYFOG005L

1 x 5 litres

C DEADLINE PYSPRAY | HSE 10718

PROFESSIONAL

SP

Contains *Chrysanthemum Cinerariaefolium* extract 0.075%, Piperonyl butoxide 0.6%

Oil based ready to use formulation, specifically designed for rapid broad spectrum control. Suitable for use in sensitive areas such as food factories and hospitals. The formulation can be used internally or externally for the control of flying and crawling insects. Apply using a sprayer or alternatively it can be brushed directly onto a target surface for precision application.



PYSRPAY005L

1 x 5 litres

D FORTEFOG P MAXI FUMER

PROFESSIONAL

SP

Contains: 13.25% w/w permethrin

Ready-to-use insecticidal smoke generator

Fortefog P permethrin fumers are simple to use in the home, factory or warehouse, and effective against a wide range of flying and crawling insects. Fumers are particularly useful in situations where spraying access is difficult or limited. Tests have shown PelGar fumers are up to ten times more effective than other brands on the market.

Available in two sizes. Fortefog P Maxi fumers will treat areas up to 1,000m³ – larger areas can be treated with multiple fumers. The Maxi fumers are designed for use in industrial / commercial environments and use the standard low-sparking fuse system.

For use against flying and crawling insects such as houseflies, cluster flies, fruit flies, mosquitoes, wasps, moths, fleas, bedbugs, ants, cockroaches and stored product insects including saw-toothed grain beetle and adult grain weevils. Fortefog P fumers can be used in domestic situations, public hygiene areas (including hospitals – not occupied wards), industrial and municipal buildings and food handling / storage / manufacturing premises, zoos, pet shops, kennels, veterinary practices and laboratory animal houses (excluding animal pens and cages) and can also be used in empty greenhouses.



FORTIMAXI

27g x 12

FORTEMINI

2.5G X 20

INSECTICIDE SMOKES

INSECTICIDE GELS AND BAIT STATIONS



WOOD TREATMENT CHEMICALS

E	WOODWORM KILLER - LIGNUM PRO 62.5 HSE 9894	PROFESSIONAL	SP
----------	---	---------------------	-----------

Contains 6.5% permethrin

Dilution 1 litre/25 litres water

A concentrated insecticidal treatment for wood-boring insect control and prevention based on the active ingredient permethrin and formulated as a micro emulsion. The formulation particle size allows the active ingredient to penetrate deep into the timber. The concentrate dilutes with 24 Litres of clean water to make 25 Litres of treatment fluid. Once diluted the product can be brushed or low pressure sprayed onto furniture, flooring, structural and other timbers to treat or prevent attack from wood boring insects. Treated areas can be overpainted, stained or varnished when dry. External and internal use, it is always advisable to try on a small inconspicuous area before application to ensure there is no effect to colour or finish.



WOODW001L 1 x 1 litre

F	AF® PINPOINT® BAIT STATION
----------	-----------------------------------

The AF Pinpoint offers a secure way of laying bait targeting both ants and cockroaches whilst protecting the bait against the environment. The versatile design allows this bait station to be positioned on both horizontal and vertical surfaces where insect pests can roam. The secure fastening allows bait to be positioned safely avoiding any harm caused to surrounding pets. Optional extra sticky pads are available to allow vertical fixing of the station. Available in black or white.

AFPIN30WHI	Box of 30 stations in white
AFPIN30BLK	Box of 30 stations in black
AFPINPADS	Box of 100 sticky pads

G	ADVION ANT GEL BPR: UK-2014-0135-0002	PROFESSIONAL	NC
----------	--	---------------------	-----------

Contains 0.05% w/w indoxacarb

Advion® Ant Gel is specifically formulated to be attractive to a wide range of pest species of ants.

This gel is based on a unique active ingredient, indoxacarb, which is bio-activated inside ants to its highly potent form, offering a different mode of action compared to other active ingredients. The slight delay in mortality caused by indoxacarb, encourages ants to consume the bait and return to nest sites to contaminate other ants, resulting in significant reduction in infestation levels. Through trophallaxis, ants share the bait with reproductive members of the colony, leading to queen mortality and complete elimination of the infestation within days of applying the gel. This high-performing formulation quickly attracts ants, even in situations with existing food sources, and it can be used in a variety of application sites, both indoor and outdoor. **Available to purchase in single tubes of 30g.**



ADV30GANT Box of 4 x 30g

H	MAXFORCE QUANTUM ANT GEL BPR: UK-2017-1097-001	PROFESSIONAL	NC
----------	---	---------------------	-----------

Contains 0.03% w/w imidacloprid

A thick liquid, highly palatable ant bait that controls both sweet and protein loving ants, including Pharaoh, Ghost, Black and Argentine Ants. Exclusive Bayer bait matrix for attractability and durability in use, and remains attractive for up to 3 months (Non drying formulation). Apply using a standard gel applicator onto horizontal surfaces or within an appropriate bait station.

Available to purchase in single tubes of 30g.



MAXQUAN30G Box of 4 x 30g

I	NIPPON ANT GEL HSE 8918	PROFESSIONAL	NC
----------	----------------------------------	---------------------	-----------

Contains 0.081% w/w spinosad

Nippon Gel has now been re-introduced containing Spinosad. It consists of a sugary bait specially formulated to appeal to black ants. Worker ants take the sweet bait back to the nest and feed it to the whole colony.



NIPGEL30 Box of 30 x 25g tubes

INSECTICIDE GELS AND BAIT GUNS



A ADVION COCKROACH GEL | BPR: UK-2010-0001 PROFESSIONAL NC

Contains 0.6% w/w indoxacarb

A cockroach gel based on a new active ingredient, Indoxacarb, which has a novel mode of action. Proven to give 'tertiary kill' - effective against German, Oriental, American cockroaches and other cockroach species.



ADV30GROACH

Box of 4 x 30g tubes

B MAXFORCE™ PLATIN | BPR: UK-2019-1216-001 PROFESSIONAL NC

Contains 1.026% Clothianidin

Maxforce Platin is a clothianidin-based ready to use insecticidal gel bait for the control of cockroaches and silverfish, in the various stages of their development (nymphs and adults). Contains 'BlueBead' feeding stimulant technology along with foodstuffs which are particularly palatable. For use in domestic, public hygiene and food storage premises.



MAXPLATIN4X30G

Box of 4 x 30g tubes

C TECH REACH EXTENSION

The Tech-Reach Bait Pro is a fantastic new tool that gives technician's the ability to reach far above, behind and around customer's items. No bait is wasted because the bait tube attaches on the end of the 24" extension.

TECHREACH

Each

D PLASTIC APPLICATOR GUN

A lightweight, cost effective plastic bait gun for use with a wide range of gel baits. **No tips provided with this applicator.**

PLASTAPLGUN

Each

E 1" STAINLESS STEEL BAIT GUN TIPS

Replacement 1" stainless steel tips for use with applicators and gels.

BAITTIPST

Pack of 25

F 1" PLASTIC BAIT GUN TIPS

Replacement 1" plastic tips for use with applicators and gels.

BAITTIPPLAST

Pack of 25

BAIT GUNS

INSECTICIDE AEROSOLS



G



H



I



J



K

G PISTOL CASE

A Polypropylene carry case ideal for storing application guns safely. Contains egg-shell interior.

PISTOLCASE Each

H VAZOR ICE PROFESSIONAL/AMATEUR **SP**

HAZARD INFORMATION: H222, H229, EUH401, P210, P211, P251, P410 + P412

A ready-to-use freezing spray that works through cold technology (below -40°C) to eliminate most crawling and flying insects quickly and efficiently. Insects, upon direct contact with the freezing spray-jet, are controlled quickly. It does not contain insecticides and leaves no residue.

 **VAZORICE500ML** 1 x 500ml

I ENVU/BAYER FLYING INSECT KILLER™ | HSE 8771 PROFESSIONAL/AMATEUR **SP**

Contains 0.15% w/w d-tetramethrin and 0.15% w/w d-phenothrin | HAZARD INFORMATION: H222, H229, H410, EUH401, P210, P211, P251, P410 + P412, P501

This highly effective water based formulation for professional and amateur use is approved for use in a wide variety of areas, and control both Flying and Crawling Insects. Provide quick control and rapid knockdown.

 **BAYERFLY** 12 x 400ml

J FLEXIBLE AEROSOL STRAW KIT

Flexible extension straws for Racumin Foam and other aerosol sprays such as Envu Flying Insect Killer. The straws come supplied in a multi pack containing:

- 1 x 60cm flexible straw
- 1 x 30cm flexible straw
- 1 x cleaning tool
- 1 x actuator cap & connector (fits all common 4mm male aerosol valves)
- 1 x additional spare actuator cap

Made from robust chemical resistant tubing, the straws can be bent to the required shape and stay put.

AEROSTRAWKIT Each

K DIGRAIN CONTROL PROFESSIONAL **SP**

Contains 0.25% Permethrin, 0.24% Tetramethrin

Treats both flying and crawling insects. One of the strongest on the UK market. Proven knock down and efficacy in the field.

 **DIGRAINCONTROL** 1 x 600ml

INSECTICIDE AEROSOLS

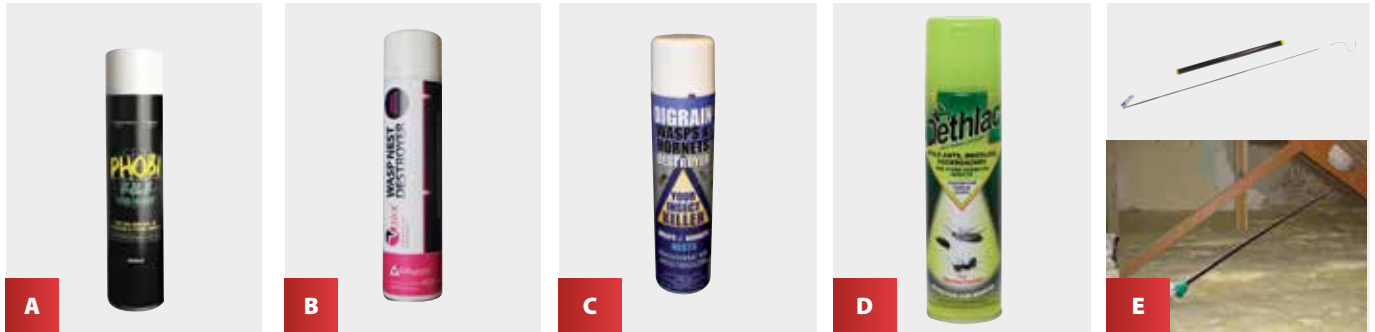
**A** PHOBI F&F ONE SHOT | HSE 10192

PROFESSIONAL

SP

Contains 0.11% imiprothrin & 0.33% cyphenothrin

A quick knockdown and moderately residual broad spectrum one-shot aerosol for space spraying, based on a combination of pyrethroid ingredients. For the control of cockroaches, fleas, flies, bedbugs, mosquitoes and other flying and crawling insects including confused flour beetles and biscuit beetles. Areas of use are in enclosed indoor situations, domestic premises, food preparation premises, kitchens and bakeries.



PHOBIONE

1 x 300ml

B VAZOR® WASP NEST DESTROYER | HSE 9817

PROFESSIONAL

SP

Contains 0.27% Permethrin, 0.11% Tetramethrin

A powerful foam wasp nest destroyer for killing wasps in the nest. This professional treatment is easily applied from a safe distance directly onto a nest providing quick and effective control. The nest should be treated late evening or early morning when the wasps are less active.



VAZORWASPFOAM

1 x 600ml

C DIGRAIN WASP & HORNET DESTROYER | HSE 7644

PROFESSIONAL

SP

Contains 0.25% Permethrin, 0.24% Tetramethrin

One of the strongest wasp destroyers on the market. Pressurised aerosol - can spray up to 18 feet! Proven knock down and efficacy in the field.



DIGRAINWASP

1 x 600ml

D DETHLAC INSECTICIDAL LACQUER AEROSOL

PROFESSIONAL / AMATEUR

SP

Contains 0.02% deltamethrin and 0.08% pyrethrins

HAZARD INFORMATION: H222, H229, H319, H336, H410, P102, P210, P211, P251, P260, P273, P337 + P313, P351, P410 + P412, P501

Dries as a hard lacquer, therefore increasing residuality. Can be used indoors and outdoors on hard surfaces.



DETH12X250ML

12 x 250ml

E AEROSOL 3

Aerosol 3 is a 3.25m adjustable telescopic lance that attaches to aerosol products such as Digrain Wasp & Hornet Nest Destroyer & Bayer Flying Insect Killer.

- Designed specifically for closer range precision treatment ideal for attics and confined areas.
- Lance has adjustable length of 1 m to 3.25 m.
- Reduces time taken to treat nests.
- Useful in unfloored attics, eliminating the need for walking boards.
- Stores in to a compact 1.3 m long PVC Protective Carry Tube.

AEROSOL3

Each

ATTRACTANTS AND LURES

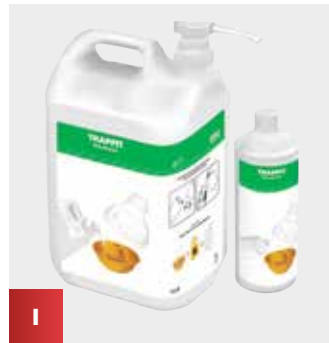
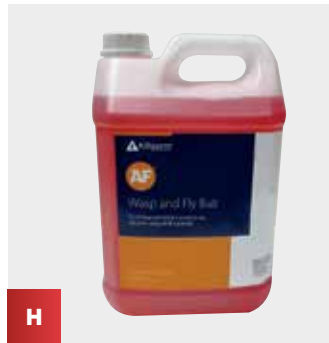

F AF WASP AND FLY TRAP

The AF Wasp and Fly trap is a reusable trap made from hardwearing polypropylene. Ideal for use in all areas where wasps and flies need to be controlled, such as food storage and processing areas, patios, beer gardens, bin storage and leisure areas. The trap is supplied with an easy to fit hanging cord which can be attached through eyelets in the trap lid. The trap base has raised feet which also allow the trap to be used on flat surfaces if required. The trap should be serviced regularly, removing dead insects and re-filling with fresh liquid bait. Liquid Wasp & Fly Bait sold separately.

AFWASPTRAP6	Pack of 6
--------------------	-----------

G DOME FLY AND WASP TRAP

For use in food storage and processing areas, on patios and around BBQ areas, in beer gardens and around caravan sites. The trap should be serviced regularly, removing dead insects and re-filling with fresh liquid bait. Supplied without bait.

DOMEOONLY	Each (Individually boxed)
DOMEMEGA	Outer box of 40

H AF WASP AND FLY BAIT

The AF Wasp and Fly Bait is a poison-free, non-toxic, food-grade lure, that is highly attractive to both *Vespidae* (wasps) and *Muscidae* (synanthropic flies) species. AF Wasp and Fly Bait is not based on protein bait, therefore does not have an unpleasant odour and does not require activation time (fermentation process of protein-based baits requires a few days to make the trap active). It can be used in the vicinity of human activity, providing immediate effective action against both wasps and flies.

- Poison-free.
- Non-toxic.
- Lasts for 4 weeks.
- Safe to the environment.
- Safe to non-target species.
- Does not attract honey bees and bumblebees.
- Odourless.
- Effective against both wasp and flies.
- Immediate efficacy, no activation time.

AFWASPBAIT005L	1 x 5 litres
-----------------------	--------------

I TRAPPIT LIQUID WASP BAIT

An economical, ready-to-use bait that attracts flies and wasps. For use in any liquid bait insect trap. Contains a Bee-repellant.

DOMEA001L	1 x 1 litre
------------------	-------------

ATTRACTANTS AND LURES

ANTI-STATIC



A



B



C

A DISPOSABLE WASP BAG

Effective, safe and easy to use disposable trap, designed for use outdoors. Each trap requires 500ml of Suterra Liquid Wasp and Fly Bait, and once full of dead wasps close screw cap and dispose in household waste. Liquid Wasp & Fly Bait sold separately.

WASPBAG	Each	
----------------	------	--

B FLEA TRAP

For estimating and monitoring flea infestations. The flea trap is supplied with a screw-in bulb and 1 pad.

FLEATRAP	Each	
FLEAPADS	Pack of 6 sticky pads	
FLEABULB	Spare bulb (screw)	

C IK9 - PC SPRAYER

A lightweight sprayer with polypropylene tank complete with viton seals, pressure regulator, directional lance and safety valve.

IK9SPRAYE	6 litre sprayer	
------------------	-----------------	--

Dismate PE

Sustainable Moth Management System



DISMATE PE

Dismate PE is a powerful system used to combat food moths present in food processing, manufacturing and distribution facilities. The pheromone-based technology works as a mating disruption system that has been used successfully in the food industry for many years. Dismate PE is a preventative and curative treatment for food moth infestations in facilities such as cereal manufacturing facilities, chocolate factories, large scale commercial bakeries, nut or dried grain storage and grain silos. Mating disruption technology is recommended for professional use to combat: Indian meal moth, *Plodia interpunctella* – Mill moth, *Ephestia kuehniella* – Warehouse moth/ Cocoa moth, *Ephestia elutella* – Tropical warehouse moth, *Cadra cautella* – Raisin moth, *Cadra figulilella*.

Dismate PE offers *Plodia/Ephestia* control in a non-toxic, residue free way that results in no down-time for the facility, saving time and money. The long-life sachets are active for up to 3 months and come in four colours to enable easy servicing for the pest controller. The sachets are metal detectable to provide additional safety measures.

Dismate PE works by disturbing the communication between male and female through:

- Masking the pheromone trail left by the female.
- Exhaustion of males through sparking premature excitation in their search for females.
- Confused males can then be found stationary and hovering around high pheromone release dispensers.

Each pack of 5 dispensers are supplied with a cable tie to fasten to already installed brackets. If new brackets are required, these can be purchased separately.

DISMATEPEBLU	Pack of 5	Jan-Mar	Blue	
DISMATEPEGRE	Pack of 5	Apr-Jun	Green	
DISMATEPERED	Pack of 5	Jul-Sep	Red	
DISMATEPEVEL	Pack of 5	Oct-Dec	Yellow	
DISBRACK50	Pack of 50 Brackets			

AF® Insect Monitoring System

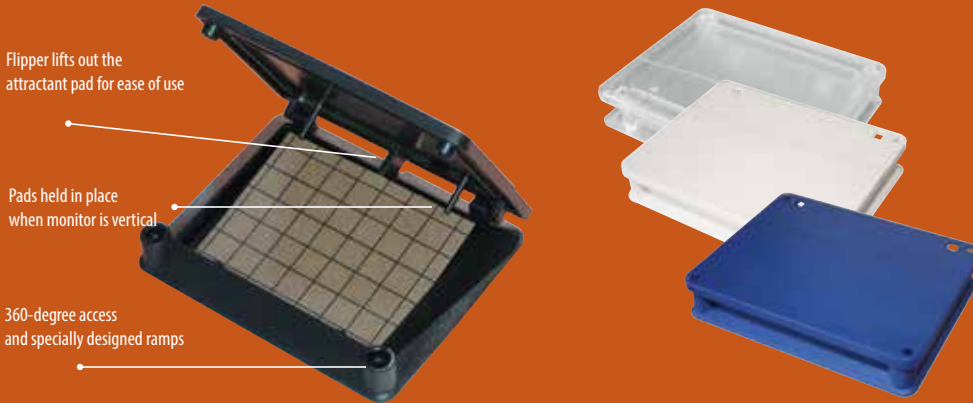

Flipper lifts out the attractant pad for ease of use

Pads held in place when monitor is vertical

360-degree access and specially designed ramps

- Slimline profile means it can be placed in narrow gaps, closer to insect activity
- Slimline profile prevents entry by non-target species, such as mice
- The unique “flipper” design automatically lifts out the attractant pad for easy inspection and convenient removal
- 360-degree access and the specially designed ramps mean the insects commit to entering the trap from all directions
- Insects are unable to detect the sticky surface until it's too late, they will not avoid entry
- The textured surface and optimum ramp angle add to ease of entry and the narrow leading edge does not deter smaller insects
- Will fit on to the AF Advance Mouse Box & AF Snappa forming Integrated Monitoring/Control System to monitor both rodent and insect activity
- Corporate printing available

AF150BLA	Black	Box of 50	
AF150WHI	White	Box of 50	
AF150BLU	Blue	Box of 50	
AF150CLE	Clear	Box of 50	

AF® Location Bracket

The AF Location Bracket is exclusive to the AF Insect Monitoring System. It can be used to floor mount the insect monitor alone or when used in conjunction with the AF Integrated Monitoring/Control System (when the AF Advance Mouse Box and AF Insect Monitoring System are attached). The location bracket enables the easy removal of the insect monitor when dating and cleaning.



AFIBRACK	Location Bracket	Each	
----------	------------------	------	--

AF® Cockroach & Crawling Insect Monitor Glue Pad

- Pad contains its own integrated attractant system eliminating the need for separate attractant tablets
- Special slow release matrix, which remains effective for as long as the pad remains sticky
- Pads are colour-coded in red
- Standard size fits most plastic insect monitoring stations
- Printed grids make counting easier



Pads are non-species or sex specific and attract a wide range of insect species in all mobile life stages, making it an invaluable IPM monitoring tool.

AFI100CRA	Glue Pads	Pack of 100	
-----------	-----------	-------------	--

AF® Insect Monitoring System

The AF Advance Mouse Box has been designed so that it fits securely onto the AF Insect Monitor, making servicing faster and easier.



AF® Demi-Diamond & Glue Pads



- A versatile flying insect monitoring station designed for use in areas where Stored Product Moths (Ephestia and Plodia) and Textile Moths (Tineola bisselliella) are a problem.
- Patterns of triangular holes allow easy access to flying insects whilst making inspection quick and easy.
- Glue board is simple and quick to change.
- Supplied flat - ready for assembly.
- The attractant in these glue pads is pheromone based, using the same slow release matrix technology as the crawling insect glue pad, no need for fiddly attractant tablets.
- One pad for both Ephestia species and Plodia species.
- One pad for Tineola bisselliella species.
- Can be wall mounted, free standing or hung on all popular curtain and clothes rails.

THE AF® DEMI-DIAMOND® TRAPS

AFDEMI50C	PK 50 DEMI-DIAMOND TRAPS (CLEAR)	
------------------	---	--

GREEN: EPHESTIA/PLODIA PHEROMONE MONITORING PADS

AFD100EPH	Pack of 100 pads	
------------------	-------------------------	--

BLUE: TINEOLA BISSELLIELLA PHEROMONE MONITORING PADS

AFD100TIN	Pack of 100 pads	
------------------	-------------------------	--

- The AF Demi-Diamond can also be used to monitor areas where Fruit fly (Drosophila) are a problem.
- Small reservoir at the bottom of the monitor means attractants can be added to maximise the monitors efficacy.
- Yellow glue board means maximum attractiveness to flying insects.

AFDEMIFRU	Pk 100 Fruit Fly Glue Pads	
------------------	-----------------------------------	--

- The AF Demi-Diamond is available in blue that is suitable for use in the food industry.

AFDEMIBLUE	Pk 50 Demi-Diamond Traps (Blue)	
-------------------	--	--



WAREHOUSE - GRID SYSTEM

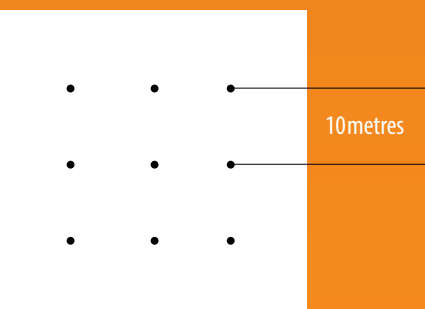

VIDEO AVAILABLE ONLINE
www.killgerm.com

GOT A SMART PHONE
 Visit your app store to find a
 barcode reader for your device

MONITORING TRAPS



INTEGRATED PEST MANAGEMENT

It is essential that pest control programmes are monitored so that levels of infestation and the efficacy of treatments may be determined. Killgerm's range of monitoring traps are designed to allow you to monitor for a wide variety of insect species in different environments.

Based on insect attraction (as pheromones, food attractants or a combination of both) the traps work constantly as monitors of pest populations in food storage and preparation areas.

A BLACK STRIPE MOTH TRAP

For the monitoring of moth pests of stored food. Gives early warning of infestation. At least one trap per 600m³ should be used in areas subject to infestation eg. incoming goods and storage areas, manufacturing and production areas, connecting aisles and passage ways. Dispensers should be replaced every 6 weeks. Supplied with dispenser carrying cap, trap record card, 4 pheromone dispensers. Ideal for dusty conditions.

FUNNELBLA	Each
------------------	------

B PHEROMONE DISPENSERS

Standard pheromones to fit in the Black Stripe Moth Trap. Should be replaced every 6 weeks.

FUNNELFIL	Pack of 10
------------------	------------

C XLURE LONG-LIFE LURES

Effective against *Ephestia* and *Plodia interpunctella* species. A four coloured, long-life dispenser for Stored Product Moth monitoring and detection. The year round rotation of pheromones helps improve pest management practice making change of dispensers more visible to technicians and customers. Should be replaced every 3 months.

XLUREBLUE	Pack of 10	Jan-Mar
XLUREGREEN	Pack of 10	Apr-Jun
XLURERED	Pack of 10	Jul-Sep
XLUREYELLOW	Pack of 10	Oct-Dec

D FUNNEL LINERS

Shaped plastic liners designed to fit in the Black Stripe Moth Trap coated with specially formulated non-drying insect glue. Used to replace insecticide and other killing agents.

FUNNELLIN	Pack of 10
------------------	------------

E AF® DEMI-DIAMOND®

A versatile flying insect monitoring station designed for use in areas where Fruit Fly, *Ephestia/Plodia* and *Tineola bisselliella* are a problem.

AFDEMI50C	Pk 50 Demi-Diamond traps (Clear)
AFDEMIBLUE	Pk 50 Demi-Diamond traps (Blue)
AFDEMIFRU	Pk 100 Fruit Fly Glue Pads
AFD100EPH	Pack of 100 <i>Ephestia/Plodia</i> pheromone monitoring glue pads
AFD100TIN	Pack of 100 <i>Tineola bisselliella</i> pheromone monitoring glue pads

MONITORING TRAPS

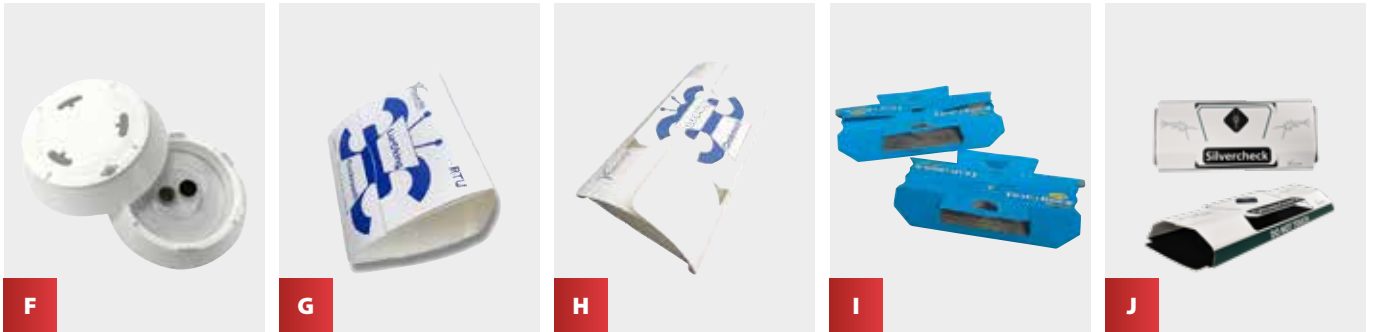

F XLURE-FIT

Xlure-FIT is a fabric insect trap which contains a special mix of attractants and insect pheromones. Xlure-FIT trap can be used to monitor clothes moths and carpet pests such as the webbing clothes moth, *Tineola bisselliella*, the case bearing clothes moth, *Tinea pellionella*, the varied carpet beetle, *Anthrenus verbasci*, the black carpet beetle, *Attagenus unicolor*.

XLUREFIT	Box of 5	Complete Traps	
XLUREFITREFILL	Box of 10	Refills	

G LUREKING NO12 CORNER TRAP

Enhanced, ready to use traps with an integrated, improved attractant. Offering protection before, during and after treatment, the Lureking No12 is a smaller discreet trap that fits perfectly into a corner, easily hidden around equipment or furniture. The traps are a safe, non-toxic solution to monitoring all types of cockroaches. Once assembled there is no need to add a lure as it is already included in the glue. The traps are highly effective for detecting low level populations, but also have a high capacity to be used as a substitute for when conventional insecticide is not safe to use e.g. In the food industry. The Lureking traps detect a potential problem before the population increases, they are ideal for locating problem areas of harbourage enhancing control efforts and allowing pest controllers to intensify treatments in certain areas. Supplied as 100 sets of 3 traps.

LUREKINGNO12	Box of 300	
---------------------	------------	--

H LUREKING NO30 LOWLINE TRAP

Enhanced, ready to use traps with an integrated, improved attractant. Offering protection before, during and after treatment, the Lureking No30 is a lowline trap that can be slipped under shelving and into tight spaces. The traps are a safe, non-toxic solution to monitoring all types of cockroaches. Once assembled there is no need to add a lure as it is already included in the glue. The traps are highly effective for detecting low level populations, but also have a high capacity to be used as a substitute for when conventional insecticide is not safe to use e.g. In the food industry. The Lureking No30 traps detect a potential problem before the population increases, they are ideal for locating problem areas of harbourage enhancing control efforts and allowing pest controllers to intensify treatments in certain areas.

LUREKINGNO30	Pack of 10	
---------------------	------------	--

I HOY HOY TRAP-A-ROACH

The Hoy Hoy Trap is ideal for monitoring levels of cockroach infestation. It has a sticky floor, approximately 15cm x 10cm with a food attractant sachet to entice cockroaches to enter the trap. The brand leader.

TRAPARNEW	Box of 100	
TRAPARPKS	Box of 5	

J SILVERCHECK TRAP

This ready-to-use Silverfish and Greyfish Trap is a self-contained and user friendly cardboard station with a powerful sticky base. Included with this product is a sachet of lure powder which is highly effective in attracting crawling insect pests. The trap can be used to effectively control both Common Silverfish (*Lepisma saccharina*) and Grey Silverfish (*Ctenolepisma longicaudata*) infestations. Simple and effective, these traps are ideal for use in large or small spaces in both private and public areas. Size 200mm x 94mm.

SILVCHECKTRAP10	Pack of 10	
------------------------	------------	--

MONITORING TRAPS

FLY TRAPS



A XLURE MST

This is a truly indispensable tool for the monitoring of crawling insects in the dry food chain. It is capable of attracting and trapping practically all crawling stored products insects with a high degree of efficiency. With three pheromones and two food attractants, the Xlure- MST is a powerful multi species trap capable of detecting beetles, weevils and mites in its vicinity. It can be used in various conditions including areas of high dust. It comprises a main trap structure made of a sturdy plastic shell and ramp fitted with a replaceable pre-baited and ready to use cartridge.

XLUREMST	Box of 5	Complete traps	
XLUREMSTREFILL	Box of 10	Refills	

B PITFALL CONE TRAP

For the detection and identification of Grain Storage Beetles & Weevils in stored grain. The ten traps come complete with marker tags and should be placed in pairs in the grain 5-6m apart. One at the grain surface and one at 8-15cm depth.

One pack per 200-300 tonnes of stored grain recommended. The traps come coated with a non-stick PTFE solution applied to stop insects escaping. Unbaited.

PITFALL	Pack of 10	
----------------	------------	--

C INSECTRAC CL

Unique pheromone system for long-term population management and damage reduction of clothes moth *Tineola bisselliella*. CL Tab employs pheromones for long term population management, specifically for clothes moth *Tineola bisselliella*. Using patented Entostat powder technology, the Insectrac CL Tab induces a transfer of pheromone among male moths to create a confusion effect. This process, called 'Auto-Confusion', spreads pheromone throughout the male moth population thereby interrupting the mating cycle and reducing the moth population. The product is ideally designed to be discrete for professional textile, heritage, costume storage and numerous other sites vulnerable to clothes moth attack. The Insectrac CL Tab system is simple to deploy with the associated CL Tab Holder. These can be kept permanently in place and the CL Tab replaced every 2 months. CL Tabs are supplied in packs of 24 tabs to effectively treat up to 600m². Use in conjunction with monitoring traps throughout the treatment area to assess the level of infestation. Over time a reduction in moth numbers being caught, indicates the effectiveness of the Insectrac system working.

INSECTRACCLTAB	Pack of 24 Tablets	
INSECTRACCLDISP	Pack of 24 Dispensers	

FLY TRAPS

D DISPOSABLE FLY BAG

The Fly Bag Trap is an effective way to lure blue bottle, green bottle and house flies away from sensitive outdoor areas with the specially formulated food grade attractant contained within a water soluble sachet. The flies are caught and trapped inside the bag which can be disposed of once full of flies. Ideal for outdoor use in farms, stables, gardens and bin areas.

FLYBAG	Each	
---------------	------	--

E REDTOP FLY CATCHER

A disposable non toxic fly trap used outdoors to draw flies away from affected areas. The trap is suitable for domestic use in gardens, arming & breeding environments, food preparation areas & anywhere that flies tend to gravitate. 85% of flies trapped are egg laying females and this contributes to controlling the fly population in the area. The Red Top Trap exploits the survival instincts in order to trap them, the flies can therefore never become immune to the lure.

REDTOPDISP	Each	
-------------------	------	--

FLY TRAPS

FRUIT FLY TRAPS

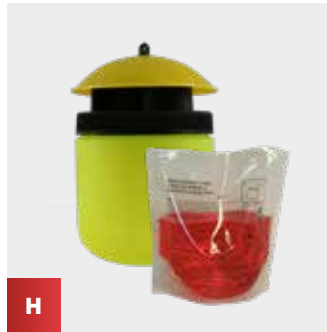
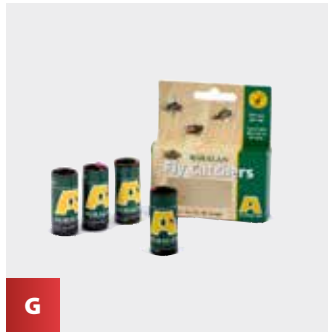

F GOLD STICK FLY TRAPS

The Gold Stick is a highly effective insect trap that is safe to use in all areas. Contains no toxins, insecticides, hazardous chemicals and emits no vapours or offensive odours. Gold Sticks are long lasting and can be used in both internal and external areas. The combination of lures that are contained in the Gold Stick are highly attractive to flies and other nuisance flying insects. Gold sticks can be used horizontally, free standing or hung vertically. The large version measures 24", the small version 12".

GOLDSTICKSMALL	Each	
GOLDSTICKLARGE	Each	

G STICKY FLY PAPERS

A non-toxic fly paper that does not contain any attractant.

FLYPAPERS	Pack of 4	
------------------	-----------	--

H AF FRUIT FLY TRAP

The AF Fruit Fly Trap is a poison free device for monitoring fruit flies (*Drosophila melanogaster*) in commercial, residential and industrial premises such as bakeries, groceries, confectioneries, restaurants, offices, and similar locations. It is excellent at locating the source of fruit fly infestation through monitoring the count in the trap. It lures adult fruit flies, and therefore it is a perfect tool for mapping infestation levels.

Supplied as a pack of 6 traps and 6 x 200ml lures, with additional packs of lure also available.

AFFRUITTRAP	Pack of 6 traps and 6 x 200ml Lure	
AFFRUITLURE200ML	Pack of 6 x 200ml replacement lure	

I AF® DEMI-DIAMOND® FRUIT FLY TRAPS

A versatile flying insect monitoring station designed for use in areas where Fruit Fly, *Ephestia/Plodia* and *Tineola bisselliella* are a problem.

- Small reservoir at the bottom of the monitor means attractants can be added to maximise the monitors efficacy.
- Yellow glue board means maximum attractiveness to flying insects.

AFDEMI50C	Pk 50 Demi-Diamond traps (Clear)	
AFDEMIFRU	Pk 100 Fruit Fly Glue Pads	

BEDBUG PRODUCTS



A



B



C



D



E

A SENSICI PYRAMID™

The SenSci Pyramid™ is a revolutionary new glueboard specifically designed for bedbugs. This design combines the efficacy of pitfall traps with the affordability of glueboards in one seamless design. Although research has seen typical glueboards as ineffective for bedbugs, experience and technology has been used to develop a glueboard that is highly effective for bedbugs. The Pyramid can also be used for other pests including cockroaches, whereby a cockroach lure can be added.

SENSICYPYRAMID Pack of 24**B BUGSCENTS BEDBUG LURE**

The BugScent bedbug lure, developed by experts at the London School of Hygiene and Tropical Medicine, is an aggregation-pheromone-based lure that can be applied via the AF crawling insect monitor or SenSci Volcano. The bedbug aggregation pheromone attracts nymphs, females and males irrespective of whether they have fed or not. The lures are long-lasting and remain active for approximately 12 weeks. The shelf life is expected to exceed 18 months. This new lure is the product of over 12 years' research by world-leading experts in medical entomology and chemical ecology. Led by Professors Mary Cameron and James Logan, Killgerm is pleased to present a science-based and evidence-led bedbug monitoring product to the market. Monitoring for bedbug activity is an essential part of an integrated pest management plan.

BUGSCENTLURE Pack of 3 x 2.4g**C LUREKING BEDBUG MONITOR**

The Lureking Bedbug Monitors offer protection before, during and after treatment. They can be slipped under or behind a bed, behind curtains or easily hidden in tight spaces around furniture. The Lureking Bedbug Monitors are a safe and non-toxic solution to monitoring bed bugs. Once assembled there is no need to add a lure as it is already included in the glue. The rough card exterior on the ramps enables the bed bugs to climb easily into the trap. The shiny card surface on the inside prevents them from escaping. The traps are highly effective for detecting low level populations before they get out of control. Checking and marking the monitors weekly can help with early detection to alert pest controllers of the need for treatment before the population increases. They are ideal for locating problem areas of harbourage, enhancing control efforts and alerting pest controllers to areas/rooms where they need to intensify treatments.

LUREKINGBB Pack of 100 (50x2)**D CIMEX ERADICATOR**

A non-chemical, non-contact, eco-friendly solution for the elimination of bedbugs. Ideal for use as part of the integrated management of bedbugs. The Cimex Eradicator is a steam generator which uses steam heated to 180°C to eliminate bedbugs. The flow of steam from the nozzle at 180°C is able to eliminate the adult insects, the nymphal stages and the eggs by causing thermal shock. The Cimex Eradicator can be stored/transported in a B&G Carry Case.

CIMEXERAD Each**E HP MED SOLUTION**

HP Med Solution is the detergent which, when combined with the superheated steam of the Cimex Eradicator, eliminates the characteristic smell of bed bugs and melts the gluey substance which binds the eggs to surfaces. Each pack contains 2 x 50ml bottles and 4 wicks.

CIMEXHPMED2 Pack of 2

BEDBUG PRODUCTS



F



H



I

F STEAM ACCESSORIES KIT

The Cimex Eradicator Steam Accessories Kit is the ideal tool for transforming the Cimex Eradicator into a perfect steam cleaner. In addition to eliminating bed bugs, the Cimex Eradicator becomes the ideal ally for deep cleaning. The steam kit contains:

- extension hoses
- floor brush
- small brush
- flexible hose handle
- window cleaning accessory
- steam concentrator with nylon brush
- cotton cloth
- cotton sockette

CIMEXSTEAMKIT Each

H CLIMBUP INSECT INTERCEPTOR

The ClimbUP makes bedbug monitoring easy. When used under where people are sleeping, the ClimbUP will make visible very low levels of bedbug infestation to any observer. The exterior climbing surface is white paper. The ClimbUP is round with total diameter of 6" and a height of 1". The centre well diameter is 3¾".

CLIMBUP4 Pack of 4

I CARRY CASE FOR CIMEX HOSE

A steel case with foam insert, specifically designed to hold the Cimex Eradicator Hose. Hose not supplied.

CIMEXHOSECASE Each

Chameleon[®] QUALIS

with QUANTUM[®] X LED technology



The revolutionary UV LED fly control unit the market has been waiting for!

Lowest power consumption, consistent with superior flying insect attraction

A bliss to service - LED tubes require replacement only once every 3 years

PestWest[®] LED sticky board with specially formulated adhesive

Full metal construction

3-year guarantee^(*) and certified to the latest international legislation

For more information please visit
www.pestwest.com

Confidence in
Fly Control

OPTIMISED SPECTRAL DISTRIBUTION

The majority of the UVA light output of Quantum® tubes is concentrated in the spectrum between 350-380 nanometers. Extensive scientific research sponsored by PestWest and carried out at the University of Birmingham in the UK proved that this is the most attractive spectrum for urban flies. In 1997 PestWest approached Sylvania Lighting International (SLI) to apply the knowledge obtained from this research and after a 2 year development and trials period the Quantum® tube was born.

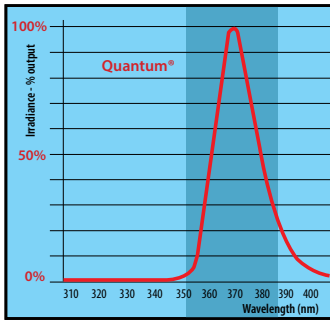

MAXIMUM SAFETY WITH FEP SHATTERPROOF COATING

Not all shatterproof coatings are the same because their quality depends on the material used.

Quantum® shatterproof tubes are coated with a high quality FEP shatterproof coating which has an excellent UVA-transmission of up to 97%.

The FEP coating also features excellent impact resistance and guaranteed glass retention. It will not melt, flake, discolour nor drip and complies with international standard EN 61549 for shatterproof tube coatings.

MEETING ENVIRONMENTAL CONCERNS

Quantum® tubes meet the most environmentally responsible standards and comply with the requirements of the Restriction of Hazardous Substances (RoHS) legislation, under which the manufacture of BL350 tubes has been banned in Europe for environmental reasons. Quantum® tubes are manufactured to the highest quality using the latest water-based phosphor technology.

MAINTAINING HIGH UVA OUTPUT

UVA light emitted from tubes varies greatly depending on the type of phosphors used and the quality of the manufacturing process. The wrong phosphor mix and any lack of quality control leads to very low product performance.

The special phosphor mix used in Quantum® tubes and a quality control system to international standards give high initial UVA output while maintaining more UVA light over the tube's lifetime (see graph below). As a result, PestWest Quantum® tubes guarantee the user highly effective performance throughout their entire life-span.

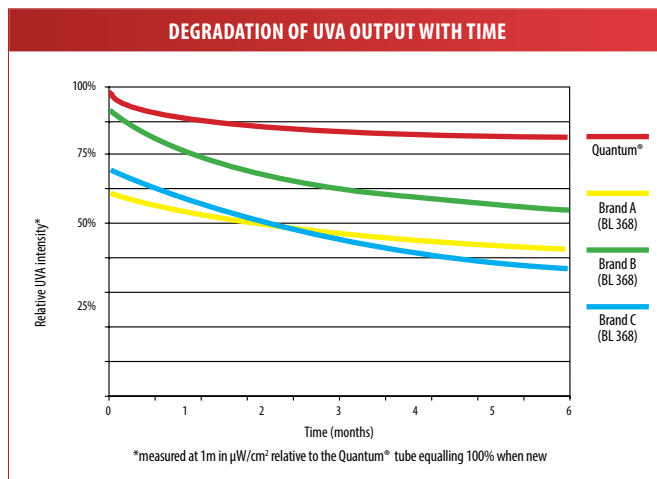

The study on the UVA light output above compares the PestWest Quantum® tubes against several popular generic BL368 UVA tube brands.



PestWest[®]
www.pestwest.com

WHY CHOOSE PESTWEST?



The PestWest comprehensive range of electronic fly killers and sticky trap units provides a suitable choice for every situation from domestic to specific industrial use. It includes a specialist range featuring high IP ratings and flameproof electrical enclosures giving protection against the most hazardous and potentially dangerous areas (ATEX zones).

The professional range of electronic sticky trap units offers highly efficient and environmentally responsible fly control with unique designs that conceal the glue board and insect catch. The popular Titan® models are suited to medium size premises, whilst the decorative range of sticky traps is ideal for restaurants, hotels, retail shops and domestic use.

- Unsurpassed reliability, giving low maintenance costs.
- Designed and built to stringent specifications and from the highest quality components for long life and efficiency. All machines carry a 3-year guarantee.
- Superior design, quick and easy no-tool servicing to save time and money.
- Quantum® tubes fitted - 100% more effective and 40% more powerful.
- Shatter-resistant tubes coated with FEP fluoropolymer to significantly reduce the risk of glass contamination during tube change.
- Units are CE-marked and independently tested to European standard EN60335-2-59.



ELECTRONIC FLY KILLERS (EFKs)

The Electronic Fly Killers use powerful PestWest Quantum® tubes to attract flying insects onto a high voltage killing grid to eradicate them. The insects subsequently fall into a catch-tray. PestWest has been developing world leading EFKs for over 25 years. They are designed with both the professional technician and the end-user in mind. They combine robust and powerful designs with tool-free maintenance and a choice of either wall-mounted, ceiling-suspended or freestanding options.



A

A NEMESIS® QUATTRO WHITE	
This all-metal electronic fly killer combines robustness and power with energy-efficient and environmentally responsible technology making it the ideal choice for large open industrial areas. It features new higher energy efficient UVA tubes powered by a state of the art electronic ballast for optimum fly control performance with low running costs and reduced materials (glass & mercury). The unit allows for quick, easy and completely tool-free maintenance. The front guard is lockable in open position, the spring loaded killing grid can be removed for cleaning. 'Power-on' and 'grid-on' warning lights permit an inspection at a distance. Fitted with four powerful, environmentally responsible Quantum® 14 watt 21inch tubes.	
H: 42cm	W: 65cm
D: 18cm	12Kg
Wall-mounted: 240m ²	Ceiling-suspended: 480m ²
Finish: <input type="checkbox"/> White	
NEMQUA014	White Each







B

B NEMESIS® QUATTRO STAINLESS STEEL	
This all-metal electronic fly killer combines robustness and power with energy-efficient and environmentally responsible technology making it the ideal choice for large open industrial areas. It features new higher energy efficient UVA tubes powered by a state of the art electronic ballast for optimum fly control performance with low running costs and reduced materials (glass & mercury). The unit allows for quick, easy and completely tool-free maintenance. The front guard is lockable in open position, the spring loaded killing grid can be removed for cleaning. 'Power-on' and 'grid-on' warning lights permit an inspection at a distance. Fitted with four powerful, environmentally responsible Quantum® 14 watt 21inch tubes.	
H: 42cm	W: 65cm
D: 18cm	12Kg
Wall-mounted: 240m ²	Ceiling-suspended: 480m ²
Finish: <input type="checkbox"/> All Stainless Steel	
NEMQUA134	All Stainless Steel Each

ELECTRONIC FLY KILLERS (EFKs)

C TITAN® 300 WHITE

With wrap-around chrome guard giving 360° protection, this all-metal unit offers features and performance far beyond its price. Two powerful 15-watt Quantum® UV tubes coated with industry compliant FEP fluoropolymer give protection up to 180m². Ideal for shops, cafés and all commercial uses.

 H: 33cm  W: 49.5cm  D: 13.5cm  7.5Kg

 Ceiling-suspended: 180m²  Freestanding: 180m²  Wall-mounted: 90m²

Finish: White



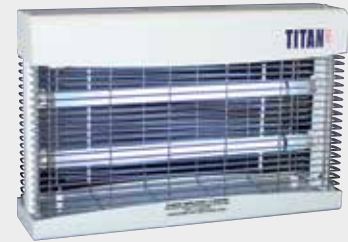

TIT300014 White Each



C

D TITAN® 300 STAINLESS STEEL

With wrap-around chrome guard giving 360° protection, this all-metal unit offers features and performance far beyond its price. Two powerful 15-watt Quantum® UV tubes coated with industry compliant FEP fluoropolymer give protection up to 180m². Ideal for shops, cafés and all commercial uses.

 H: 33cm  W: 49.5cm  D: 13.5cm  7.5Kg

 Ceiling-suspended: 180m²  Freestanding: 180m²  Wall-mounted: 90m²

Finish: Stainless Steel

TIT300114 Stainless steel Each







D

E TITAN® ALPHA

A powerful, economical & compact unit with two 15-watt Quantum® T5 tubes.

- Multiple mounting options.
- Easy and fast to service without the need for tools.
- The Titan Alpha is ideal for shops, take-aways and smaller commercial outlets.

 H: 30.5cm  W: 35cm  D: 15cm  4Kg

 Ceiling-suspended: 160m²  Freestanding: 160m²  Wall-mounted: 80m²

Finish: White

TITALP013 Each



E

PROFESSIONAL STICKY TRAPS

- Quantum® shatter-resistant tubes coated with industry compliant FEP fluoropolymer for maximum attraction and significantly reduced risk of contamination from glass breakages.
- Full-size sticky board to effectively catch even the smallest flies.
- Easy-to-remove bottom tray, drop-down guard and front covers - no tool service.
- Reflectobakt® sleeves increase attractiveness to insects, significantly slow the drying of the sticky board and allow longer board life and slimmer design.
- Interchangeable tubes and sticky boards on all units to minimise stocking requirements.

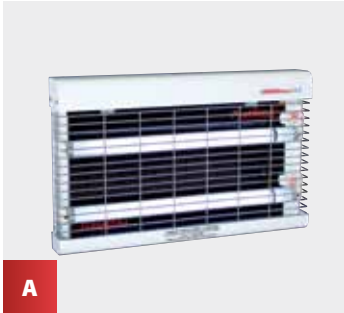

A CHAMELEON® 1X2 WHITE

Attractive, ultra-slim, wall-mounted unit (freestanding bracket available), compact and unobtrusive, ideal for use in food preparation areas. Two 15-watt powerful Quantum® UV tubes coated with industry compliant FEP fluoropolymer give 180° coverage. This popular unit is also available with a high grade stainless steel body and chrome guard.

	H: 30cm		W: 47.5cm		D: 6.5cm		4.3Kg
	Wall-mounted: 90m ²			Freestanding: 90m ²			

Finish: White

CHA1X2014	White	Each	
EF30STAND	Free-standing bracket	Each	

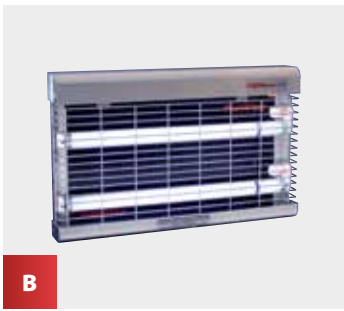

B CHAMELEON® 1X2 STAINLESS STEEL

Attractive, ultra-slim, wall-mounted unit (freestanding bracket available), compact and unobtrusive, ideal for use in food preparation areas. Two 15-watt powerful Quantum® UV tubes coated with industry compliant FEP fluoropolymer give 180° coverage. This popular unit is also available with a high grade stainless steel body and chrome guard.

	H: 30cm		W: 47.5cm		D: 6.5cm		4.3Kg
	Wall-mounted: 90m ²			Freestanding: 90m ²			

Finish: Stainless Steel

CHA1X2114	Stainless steel unit	Each	
EF30STAND	Free-standing bracket	Each	



C CHAMELEON® 1X2 DISCRETION WHITE

Built to the same specification as the Chameleon 1x2, an attractive front cover conceals the sticky board and catch, which makes this unit ideal for areas in view of the public.

	H: 30cm		W: 47.5cm		D: 6.5cm		4.3Kg
	Wall-mounted: 70m ²			Freestanding: 70m ²			

Finish: White

CHA12D014	White	Each	
EF30STAND	Free-standing bracket	Each	



D CHAMELEON® 1X2 DISCRETION STAINLESS STEEL

Built to the same specification as the Chameleon 1x2, an attractive front cover conceals the sticky board and catch, which makes this unit ideal for areas in view of the public.

	H: 30cm		W: 47.5cm		D: 6.5cm		4.3Kg
	Wall-mounted: 70m ²			Freestanding: 70m ²			

Finish: Stainless Steel

CHA12D114	Stainless steel unit	Each	
EF30STAND	Free-standing bracket	Each	

PROFESSIONAL STICKY TRAPS

- Quantum® shatter-resistant tubes coated with industry compliant FEP fluoropolymer for maximum attraction and significantly reduced risk of contamination from glass breakages.
- Full-size sticky board to effectively catch even the smallest flies.
- Easy-to-remove bottom tray, drop-down guard and front covers - no tool service.
- Reflectobakt® sleeves increase attractiveness to insects, significantly slow the drying of the sticky board and allow longer board life and slimmer design.
- Interchangeable tubes and sticky boards on all units to minimise stocking requirements.

E CHAMELEON® 2X2 WHITE

Ceiling-suspended; able to protect large open areas. Can be placed above aisles with no possibility of fly fallout. 360° attraction with four 15-watt Quantum® UV tubes coated with industry compliant FEP fluoropolymer and two full-size sticky boards.

	H: 30cm	W: 49.5cm	D: 13cm		6Kg
	Ceiling-suspended: 180m ²		Freestanding: 180m ²		
Finish:	White				
CHA2X2014	White	Each			

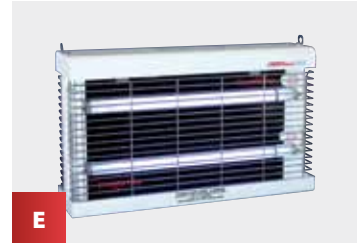

E

F CHAMELEON® 2X2 STAINLESS STEEL

Ceiling-suspended; able to protect large open areas. Can be placed above aisles with no possibility of fly fallout. 360° attraction with four 15-watt Quantum® UV tubes coated with industry compliant FEP fluoropolymer and two full-size sticky boards.

	H: 30cm	W: 49.5cm	D: 13cm		6Kg
	Ceiling-suspended: 180m ²		Freestanding: 180m ²		
Finish:	Stainless Steel				
CHA2X2114	Stainless steel	Each			



F

G CHAMELEON® UPLIGHT WHITE

This attractive wall-mounted unit is the perfect choice for areas where fly control should be discreet, e.g. restaurants and other eating areas. Disguised as a wall light with full-size sticky board and 15-watt Quantum® tube coated with industry compliant FEP fluoropolymer hidden from view. Front cover can be decorated to match existing décor.

	H: 21cm	W: 47cm	D: 17cm		3.7Kg
	Wall-mounted: 40m ²				
Finish:	White				
CHAUPL014	White	Each			



G

H CHAMELEON® UPLIGHT MAGNOLIA

This attractive wall-mounted unit is the perfect choice for areas where fly control should be discreet, e.g. restaurants and other eating areas. Disguised as a wall light with full-size sticky board and 15-watt Quantum® tube coated with industry compliant FEP fluoropolymer hidden from view. Front cover can be decorated to match existing décor.

	H: 21cm	W: 47cm	D: 17cm		3.7Kg
	Wall-mounted: 40m ²				
Finish:	Magnolia				
CHAUPL034	Magnolia	Each			



H

I CHAMELEON® UPLIGHT SILVER

This attractive wall-mounted unit is the perfect choice for areas where fly control should be discreet, e.g. restaurants and other eating areas. Disguised as a wall light with full-size sticky board and 15-watt Quantum® tube coated with industry compliant FEP fluoropolymer hidden from view. Front cover can be decorated to match existing décor.

	H: 21cm	W: 47cm	D: 17cm		3.7Kg
	Wall-mounted: 40m ²				
Finish:	Silver				
CHAUPL054	Silver	Each			

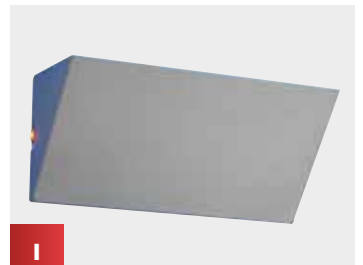

I

PROFESSIONAL ELECTRONIC STICKY TRAPS

This new range of environmentally responsible models offers innovative designs with highly efficient yet discreet fly control. All models feature an electronic ballast and unique 14 Watt T5 tubes, which are on the cutting edge of energy efficient lighting technology. Flying insects are

discreetly trapped on standard Chameleon range glue boards placed behind decorative front covers.



A

A CHAMELEON® VEGA WHITE

The Chameleon® Vega is a stylish, powerful and economical UV fly trap. With its elegant and ultra-slim design, the Chameleon® Vega features new higher energy efficient T5 14-watt UVA tubes with Reflectobakt® technology powered by a state of the art electronic ballast to deliver efficient fly control with low running costs.

H: 30cm W: 57.5cm D: 4cm 3.2Kg

Coverage: 150m²

Finish: White

CHAVGA014

White

Each



B

B CHAMELEON® VEGA STAINLESS STEEL

The Chameleon® Vega is a stylish, powerful and economical UV fly trap. Its elegant and ultra-slim design is combined with an all stainless steel construction. The Chameleon® Vega features new higher energy efficient T5 14-watt UVA tubes with Reflectobakt® technology powered by a state of the art electronic ballast to deliver efficient fly control with low running costs.

H: 30cm W: 57.5cm D: 4cm 3.2Kg

Coverage: 150m²

Finish: Stainless Steel

CHAVGA134

Stainless Steel

Each



C

C CHAMELEON® SIRIUS WHITE

The Chameleon® Sirius is a sophisticated new unit designed for front-of-house use. With its clean curves, a choice of finish and dual wall mounting options, it fits seamlessly into any restaurant, café or hotel. It features unique UVA tubes powered by an electronic ballast to deliver professional and environmentally responsible fly control. Fitted with two powerful T5 14-watt Quantum® shatterproof UV tubes.

H: 12cm W: 58cm D: 19cm 2.7Kg

Wall-mounted: 60m²

Finish: White

CHASIR014

White

Each



D

D CHAMELEON® SIRIUS STAINLESS STEEL

The Chameleon® Sirius is a sophisticated new unit designed for front-of-house use. With its clean curves, a choice of finish and dual wall mounting options, it fits seamlessly into any restaurant, café or hotel. It features unique UVA tubes powered by an electronic ballast to deliver professional and environmentally responsible fly control. Fitted with two powerful T5 14-watt Quantum® shatterproof UV tubes.

H: 12cm W: 58cm D: 19cm 2.7Kg

Wall-mounted: 60m²

Finish: Stainless Steel

CHASIR114

Stainless Steel

Each

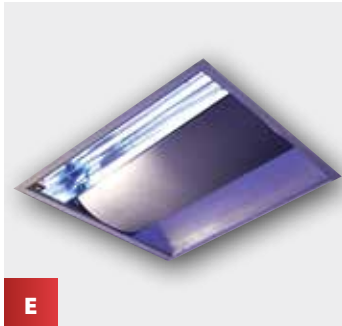

E

E ON-TOP PRO 2

Unique overhead design, to fit discreetly and easily into new or existing suspended-ceilings. Ideal for convenience stores, supermarkets and areas where space limitations may have previously made situating a standard unit difficult. The patented design avoids the possibility of fly fall-out. Two powerful T5 14-watt Quantum® shatterproof UV tubes and one strategically positioned full-size sticky board.

H: 59cm W: 59cm D: 7cm 6Kg

Ceiling-fitted: 50m²

Finish: Zintec steel body with stainless steel cover tray

OTP14W114

Stainless Steel & Aluminium

Each

DECORATIVE STICKY TRAPS

To complement the PestWest range of commercial and professional units, a set of units designed specifically for areas where fly control should be hidden from view are now available. The units come with decorative and unique front covers that hide the glue board

and insect catch. The units offer a choice of attractive, discreet and environmentally friendly sticky trap fly control, ideal for domestic use and front-of-house applications e.g. restaurants, cafés, bars, hotels and the home.

F SUNBURST® TAB

The Sunburst® TAB is the latest addition to the Sunburst range. It is destined for catering outlets in both front and back-of-house areas thanks to its concealed fly catch behind a brushed stainless steel cover. Versatile, it can be wall-mounted vertically and horizontally or suspended from the ceiling. A high quality 24 Watt compact tube powered by an electronic ballast and backed by an aluminium reflector ensures optimum fly control and reduced electricity costs.

H: 25.5cm W: 42.5cm D: 10cm  1.2Kg

 Wall-mounted: 50m²  Suspended: 50m²

Finish:  Stainless Steel

SUNTAB2113 Stainless Steel Each

BOATABUNI Replacement Sticky Boards Pack of 3





F

G SUNBURST® WHITE

Designed for front-of-house areas where fly control should be hidden from view, its elegant and decorative design conceals the glue board and the insects caught. Discreet, stylish and environmentally responsible, the Sunburst is ideal for hotels, restaurants, bars, and retail shops. It is fitted with a powerful 20 watt compact tube and can be wall mounted or freestanding.

H: 31cm W: 23cm D: 10cm  2 Kg

 Wall-mounted: 35m²  Freestanding: 35m²

Finish:  White

SUNBST013 White Each





G

H SUNBURST® SILVER GREY

Designed for front-of-house areas where fly control should be hidden from view, its elegant and decorative design conceals the glue board and the insects caught. Discreet, stylish and environmentally responsible, the Sunburst is ideal for hotels, restaurants, bars, and retail shops. It is fitted with a powerful 20 watt compact tube and can be used wall mounted or freestanding.

H: 31cm W: 23cm D: 10cm  2 Kg

 Wall-mounted: 35m²  Freestanding: 35m²

Finish:  Silver Grey

SUNBST053 Silver Grey Each





H

I SUNBURST® BLACK

Designed for front-of-house areas where fly control should be hidden from view, its elegant and decorative design conceals the glue board and the insects caught. Discreet, stylish and environmentally responsible, the Sunburst is ideal for hotels, restaurants, bars, and retail shops. It is fitted with a powerful 20 watt compact tube and can be used wall mounted or freestanding.

H: 31cm W: 23cm D: 10cm  2 Kg

 Wall-mounted: 35m²  Freestanding: 35m²

Finish:  Black

SUNBST073 Black Each



I

SPECIALIST RANGE

Hazardous and potentially dangerous areas can be difficult if not impossible to protect against flying insect pests. These areas may require units with special safety measures such as high IP ratings and can now be guarded by the PestWest specialist range of fly control units. The units are built to the highest possible specifications and accredited to the ultimate safety certification for electrical equipment. This means that sensitive and often highly dangerous

areas (Atex zones) can be protected without compromising safety standards or insurance requirements. Included in this range is the Chameleon® EXG. The introduction of this innovative unit means that flying insect control can now be undertaken in Atex classified zones where there is a high concentration of gases/vapours in the atmosphere.

J CHAMELEON® EXG X LED

NEW

Designed for use in potentially explosive atmospheres e.g. sugar refineries, distilleries, flour mills, petrochemical, and pharmaceutical industries. Suitable for zones 22 and 21, high concentration of dust / powder in the atmosphere, and zones 2 and 1, high concentration of gases / vapours in the atmosphere, according to the latest ATEX Directives 99/92/EC and 94/9/EC.

- Two powerful 18-watt Quantum® UV tubes coated with industry compliant FEP fluoropolymer.
- Fully corrosion resistant construction using 304 brushed stainless steel and marine grade aluminium alloy.
- Glass enclosure with excellent UVA light transmission providing an efficient fly control.
- Two large surface area adhesive boards enable a greater catch area and increased efficacy.

H: 80cm W: 90cm D: 30cm  14.5Kg

 Wall-mounted: 90m²

Finish:  Stainless Steel and aluminium alloy Ratings: IP66 

CHAEXG287 Each

BOAEXG883 Pack of 6



J

SPECIALIST RANGE

NEW



A

A CHAMELEON® SIRIUS X

NEW

The Chameleon® Sirius X retains the beautiful style of the Sirius whilst offering all the advantages of the Quantum® X LED technology: sustainability, excellent flying insect control performance and low running costs. Fitted with two Quantum X shatterproof tubes and the dedicated LED range glue board. Each centrally dividable replacement glue board offers two usages. Available in white or stainless steel.

	H: 19cm	W: 58cm	D: 12cm		3.1Kg
	Wall-mounted: 50-60m ²				
Finish:	White		Stainless Steel and aluminium alloy		
CHASRX014	White			Each	
CHASRX114	Stainless Steel			Each	



B

B CHAMELEON® QUALIS®

The unique Chameleon Qualis fly control system incorporates the latest UV LED tube technology Quantum X, to deliver a whole new level of fly control. Chameleon Qualis features

- Lowest power consumption, consistent with superior attraction
- Future-proof technology
- Ultra-slim attractive design
- Environmentally sustainable
- Full metal construction

	H: 30cm	W: 57.5cm	D: 4cm		3.1Kg
	Wall-mounted: 90 - 120m ²				
Finish:	White Coated Zintec Steel		Stainless Steel and aluminium alloy		
CHAQUA014	White			Each	
CHAQUA114	Stainless Steel			Each	



C

C CHAMELEON® 1X2IP

The Chameleon® 1x2IP unit is suitable for areas that are steam-cleaned, hosed down and damp or corrosive environments e.g. dairies, abattoirs and industrial kitchens. Fully tested and independently safety approved to IP66, offering a high degree of protection against dust and water, thus allowing suitability in demanding environments.

- Chassis and guard construction from brushed stainless steel for long life, durability and excellent corrosion resistance.
- Two powerful 15-watt Quantum® tubes coated with industry compliant FEP fluoropolymer
- Supplied with special plastic boards.

	H: 31cm	W: 50cm	D: 10cm		6.1Kg
	Wall-mounted: 90m ²				
Finish:	All Stainless Steel		Ratings: IP66		
CHAIP1213	All Stainless Steel unit			Each	
BOACHA872	Plastic Chameleon board			Pack of 6	



D

D CHAMELEON® 4X4

Large capacity sticky trap unit for open industrial areas. Ceiling-suspended with four 40-watt Quantum® tubes coated with industry compliant FEP fluoropolymer backed by Reflectobakt® sleeves to protect over 440m². Advanced electronic ballast for lower running costs.

	H: 61.5cm	W: 63.5cm	D: 16.5cm		12Kg
	Ceiling-suspended: 440m ²				
Finish:	White				
CHA4X4014	4x4 Industrial			Each	

SPECIALIST RANGE

F CHAMELEON® 4X4 EX

ATEX compliant all stainless steel industrial UV fly trap suitable for use in potentially explosive atmospheres in zone 22 classified areas. The 4x4 EX is a large capacity sticky trap, and also IP65 rated allowing installation in damp, dusty or corrosive environments. Four 40-watt Quantum® tubes coated with industry compliant FEP fluoropolymer backed by Reflectobakt® sleeves and powered by an electronic ballast offer improved performance and lower running costs.

H: 61.5cm W: 63.5cm D: 16.5cm 15.5Kg

Ceiling-suspended: 440m²

Finish: All Stainless Steel Ratings: IP65

CHA4X4261 All Stainless Steel Each



F

G NEMESIS® QUATTRO IP

The Nemesis Quattro IP24 is an all stainless steel industrial model, which can withstand exposure to high humidity, water splashes and corrosive atmospheres. It is both powerful and energy efficient, featuring new high efficiency UVA tubes powered by a state of the art electronic ballast for optimum fly control performance with low running costs and reduced materials (glass and mercury notably). It is equipped with 'power-on' and high voltage LED indicators, the killing grid is extractable and the front guard can be locked in open position, which all contribute to the overall ease of servicing.

H: 42cm W: 65cm D: 18cm 12Kg

Wall-mounted: 240m² Ceiling-suspended: 480m² Ratings: IP24

Finish: All Stainless Steel

NEMQUA203 All Stainless Steel Each



G

H TITAN® 200IP

Easy to install and with low running costs this weatherproof design is perfect for the agricultural market and notably on farms with livestock. The Titan 200 IP is robust and powerful with a metal casing and a quality industrial transformer that will efficiently eradicate flying insects for years. Its servicing is quick with easy access to the catch-tray and the highly powerful 20 Watt compact UV tube. Splash-proof rated to IPX4 suitable for farm conditions. All-around and environmentally responsible insect attraction with no pesticide and no risk of chemical resistance.

H: 47cm W: 30cm D: 30cm 5Kg

Wall-mounted: 160m² Ceiling-suspended: 160m²

Finish: Black

TIT200181 Black Each



H

STICKY BOARDS AND REFLECTOBAKT

I CHAMELEON® STICKY BOARDS

A black sticky glue board for use in the Chameleon range, the Mirage PRO VS & ON-TOP PRO models. Dimensions: 43cm x 24.5cm

BOACHA850 Pack of 6



I

J YELLOW CHAMELEON® MONITORING STICKY BOARDS

A yellow sticky glue board with a matrix to facilitate insect counting and identification. Suitable for use in the Chameleon® range, the Mirage PRO VS & ON-TOP PRO models. Dimensions: 43cm x 24.5cm

BOACHAYEL Yellow Pack of 6



J

K CHAMELEON® 4X4 STICKY BOARDS

A matrix sticky board for use in the Chameleon® 4x4 units. Dimensions: 60cm x 49.5cm

BOA4X4881 Pack of 6

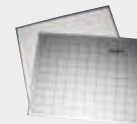

K

L SUNBURST® AND SUNDEW® STICKY BOARDS

A pack of 3 white boards for use in the Sunburst® and SunDew® units. Dimensions: 25cm x 24.5cm.

BOATABUNI Pack of 3



L

M CHAMELEON® EXG STICKY BOARDS

Large surface area matrix glue board for the Chameleon® EXG unit. Dimensions: 60cm x 42cm.

BOAEXG883 Pack of 6



M

N CHAMELEON QUALIS STICKY BOARDS

A dedicated glue board for the Chameleon® Qualis LED. Grey in colour, with a black grid and a special glue formulation. Dimensions: 48cm x 24.5cm

BOACHALED21 Pack of 6

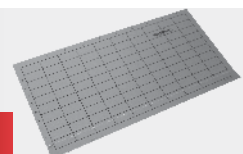

N



flyDetect® from PestWest®, the industry leader in online flying insect monitoring.

- 24/7 remote monitoring system.
- Immediate notification of emerging pest infestations.
- Customisable alert levels.
- Built-in high resolution camera captures the entire sticky board.
- Set up and monitor multiple clients.
- Temperature and humidity are recorded alongside each image.
- Scheduled UV-A tube and sticky board change notifications.
- Multiple connectivity options (Wifi, Ethernet and Cellular).
- The flyDetect® app is available on multiple platforms (smartphones and computers).

DIMENSIONS

H: 22cm W: 59.5cm D: 15cm

WEIGHT

4.5kg

COVERAGE

Wall mounted/ Ceiling-suspended: 70m²

FINISH

Black

TUBE DATA

- 2 x 15-Watt PestWest Quantum® tubes
- Shatterproof coating with industry compliant FEP
- Reflectobakt® technology



Scan the QR Code to see the flyDetect video

Each purchase of a machine includes a 1 year use voucher. Further vouchers can be purchased to extend use beyond 1 year.

FLYDET074	flyDetect Unit	
BOAFLYDET	Pack of 6 boards	
FLYDETECT1YEAR	1 year use voucher	
FLYDETECT10YEAR	10 year use voucher	

WINNER OF THE SOFHT BEST NEW PRODUCT OF THE YEAR AWARD 2020.

Flying insect control meets remote monitoring

flyDetect® is a unique remote monitoring system with a built-in camera linked to a dedicated online web & mobile app.

Now you can view all your flyDetect® traps without even being on site!

The wide-angle camera on the trap captures images of the entire sticky board, delivering full assessments in real time to wherever you are.

The permanent 24/7 monitoring system is constantly working for you, alerting you only when necessary.

flyDetect® designed to save you time and money!



PROVEN CONSISTENT QUALITY, PERFORMANCE & RELIABILITY

WHY CHOOSE QUANTUM® UV-TUBES FOR YOUR FLY CONTROL UNITS?

Spectral distribution ensures the highest UVA output at the appropriate wavelengths

- UVA light emission concentrated at around 365nm - the optimum wavelength to attract pest flies

Environmentally responsible and RoHS compliant

- 100% lead-free construction

- guaranteed lowest mercury levels consistent with optimum performance
- manufacturing process using water-based phosphor technology

Maintained high UVA output

- special phosphor mix results in slower reduction of UVA-light output

Maximum safety with industry compliant FEP shatterproof coating

Made in EU (applies to all linear tubes)







QUANTUM® SHATTERPROOF TUBES TO BS EN 61549

	CODE (FOR SINGLE TUBE)		
	TUB15W490	Quantum® 15W straight 18" shatterproof coated	Each (Box quantities of 25)
	TUB18W492	Quantum® 18W straight 24" shatterproof coated	Each (Box quantities of 25)
	TUB20W512	Quantum® 20W straight 24" shatterproof coated	Each (Box quantities of 25)
	TUB25W490	Quantum® 25W straight 18" shatterproof coated	Each (Box quantities of 25)
	TUB40W512	Quantum® 40W straight 24" shatterproof coated	Each (Box quantities of 25)
	TUB15W467	Quantum® 15W straight 12" shatterproof coated	Each (Box quantities of 25)
	TUB14W471	Quantum® 14W straight 21" shatterproof coated	Each (Box quantities of 25)

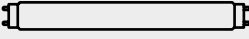
DUE TO THE WEEE DIRECTIVE, THERE ARE ADDITIONAL CHARGES PER TUBE.

OTHER UV TUBES

OTHER SHATTERPROOF UV TUBES

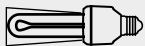
	CODE (FOR SINGLE TUBE)		
	TUB06W605	6W straight 9" shatterproof	Each (Box quantities of 25)
	TUB08W607	8W straight 12" shatterproof	Each (Box quantities of 25)
	TUB11W522	11W lynx shatterproof	Each (Box quantities of 10)
	TUB18W522	18W lynx shatterproof	Each (Box quantities of 10)
	TUB24W522	24W compact shatterproof	Each (Box quantities of 10)
	TUB22W517	22W circline shatterproof	Each (Box quantities of 12)
	TUB25W524	25W tight bend U shatterproof	Each (Box quantities of 10)
	TUB36W526	36W lynx shatterproof	Each (Box quantities of 10)
	TUB20W459	20W compact shatterproof	Each (Box quantities of 10)
	TUB13WE27SH	13W tight bend U shatterproof	Each (Box quantities of 20)

DUE TO THE WEEE DIRECTIVE, THERE ARE ADDITIONAL CHARGES PER TUBE.

Killgerm Ireland is a part of the Producer Compliance Scheme WEEE Ireland. It facilitates the collection, treatment, recovery and sound disposal of gas discharge lamps and other electrical equipment. WEEE charges have been applied to our range of tubes and the price shown includes this charge.

ACCESSORIES

A GRID TESTER

Test the killing grid on your electronic fly control unit the safe way, using the insulated "Grid Tester". Made from a non-conductive material with a metal testing button in the end, this useful tool will allow you to test the killing grid without shorting the high tension current onto the metal body of the machine, as often happens when using a conventional screwdriver.

GRIDTEST

Each

A

**B UNIVERSAL STICKY BOARDS**

Replacement sticky boards for most Brandenburg models, including the Cobra.
Dimensions: 10.2cm x 42cm

BOADBUNI

Pack of 15

B

**C STARTERS**

Replacement starter cartridges. Suitable for all current PestWest units that require a starter.

ESTSIN111

FS11 (for units with single tube circuits)

Each

ESTSER151

FS22 (For all PestWest units and most other EFks)

Each

C



What is ULV?

THE WORLD HEALTH ORGANISATION DEFINES ULV AS FOLLOWS:

"Ultra Low Volume spraying utilises the minimum volume of insecticidal formulation required to produce the desired biological effect with maximum economy" Using special formulations, applied through dedicated application equipment, ULV programmes achieve this.

HOW DOES ULV WORK?

Liquids are passed through a specially designed unit, which generates an airborne mist of droplets. These droplets diffuse through the treated area and settle out onto surfaces, meaning that the material used will be active both as a space spray and a surface spray.

The key to successful use of ULV is the production of an optimum size of spray droplet. It must be small enough to remain airborne without being too small to hit the target – research has shown the optimum droplet size to be around 15 microns.

ULV PRODUCTS

VAZOR ULV 500



PX-ULV ODOURCID



PX-ULV DISINFECTANT

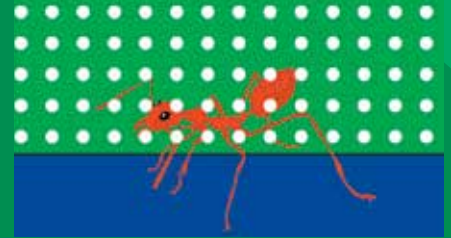

These droplets are small enough to be carried on air currents into small cracks and crevices that are hard to reach using conventional treatments, yet still heavy enough to settle out within an hour, so that treated areas can be re-entered with the minimum of delay.



The majority of droplets in a thermal fog are too small (less than 5 microns) to impinge upon the target (being unable to overcome the 'air curtain' around it).



Conventional sprays produce large droplets (over 80 microns) that quickly fall out of the air and carry a high concentration of liquid that often leaves an unsightly deposit or unpleasant odour.



exodus®

Exodus[®] ULV System...

WITH A UNIQUE PROGRAMMABLE TIMER

WHAT ARE THE KEY BENEFITS OF THE EXODUS[®] SYSTEM?

Optimum droplet size – research has shown that for public health use, ULV applicators should produce over 90% of their droplets at under 50 microns with the VMD (volume median diameter) being between 10 and 15 microns.

Independent tests carried out at Imperial College, London proved that the Exodus 8/24 produced over 98% of its droplets at under 40 microns with a VMD of between 12.7 and 13.3 microns for kerosene based products and 17.5 microns for water based products.

As it operates at optimum droplet size, less ULV product is required to achieve the desired biological effect compared to other less efficient techniques.

Economical – save money on product and treatment times.

Robust construction – the robust construction of the Exodus ensures a trouble free operation.

Shorter re-entry times – optimum droplet size ensures that the product will settle within an hour, so that treated areas can be re-entered sooner causing the minimum amount of disruption and down-time.

Versatile – the system can be used against a wide range of insects and micro-organisms in a variety of situations. Interchangeable bottles of products mean that there is a minimum wastage of chemical.

WHAT ARE THE BENEFITS OF THE UNIQUE TIMER SYSTEM?

Units fitted with the specially developed timer system have three advantages.

The first is that they can be set up during the day and operate "out of hours" when personnel do not have to be present, saving both time and money.

The digital timers are so accurate that they can be set to treat the designated area each day for between 2 seconds and 29 minutes at a time, depending on need.

The second is that, by using the timer instead of the manual control, very accurate dosing rates can be achieved by operators.

The third is that operators may set up the unit wearing normal uniforms before retiring from the room, thereby avoiding the need to wear full protective clothing, which may worry some customers.

HOW MUCH DOES USING AN EXODUS[®] ULV COST?

ULV formulations are concentrated chemicals. Because of the small droplet size and rapid dispersal of the spray cloud, very little is actually required. For example, a room that is 5m x 8m x 2.5m high (100m³) will require 10ml of a typical ULV formulation, which will take only 17 seconds to apply with the Exodus. The cost: a mere 81p in materials. The figures speak for themselves.

THE RANGE OF AREAS SUITABLE FOR ULV APPLICATION IS HUGE. HERE ARE SOME SUGGESTIONS –

- Domestic & Commercial areas
- Waste Handling
- Food preparation areas
- Vehicles
- Warehouses and storage facilities
- Animal husbandry
- Aircraft

ULV SYSTEMS...

- Economical
- Versatile
- Fast and efficient
- Short re-entry times
- Low environmental impact
- For disinfection
- For deodorisation
- For insect control



A



A EXODUS[®] ULV SYSTEM

Please note 110 volt version is available

EXODUS073

220v

B EXODUS[®] CARRY BAG

A heavy duty padded bag shoulder strap and full zip-away flap.

EXODUSBAG

Each

B



SURFACE SPRAYING EQUIPMENT



A GLORIA PNEUMATIC 5 LITRE GALVANISED SPRAYER

- High quality steel tank sprayer with a plastic internal liner protective coating.
- Maximum capacity is 8 litres and the usable spraying capacity is 5 litres. The unit is fitted with Nitrile seals.
 - Maximum operating pressure is 6 bar. The sprayer is fitted with a powerful brass pump, brass trigger valve, brass lance and pressure gauge.
 - The spray tip is customised for optimum performance for pest control applications.
 - To protect against blockage by foreign objects/particles, the sprayer is supplied with a filler funnel filter and fitted with coarse and fine in line filters.
 - The hose length is 1.35 metres and the standard spray lance length is 0.5m.
 - There is an integrated pressure release and pressure safety valve.
 - The sprayer is fitted with a base ring to aid stability and a useful storage compartment that can hold spare spray tips, o rings etc.
 - Supplied with a shoulder carry strap.

GLOJNGALV	Each	
00-900/CR	Crack and crevice nozzle for Gloria 5 litre & No. 89 sprayers	
704050	Variable spray nozzle for Gloria 5 litre sprayer	
00-900/02	Flat fan nozzle for Gloria 5 litre sprayer	

B GLORIA PNEUMATIC 5 LITRE STAINLESS STEEL SPRAYER

- A high quality, non-corroding, stainless steel tank sprayer.
- Maximum capacity is 8 litres and the usable spraying capacity is 5 litres. The unit is fitted with nitrile seals.
 - Maximum operating pressure is 6 bar. The sprayer is fitted with a powerful brass pump, brass trigger valve, brass lance and pressure gauge.
 - The spray tip is customised for optimum performance for pest control applications.
 - To protect against blockage by foreign objects/particles, the sprayer is supplied with a filler funnel filter and fitted with coarse and fine in line filters.
 - The hose length is 1.35 metres and the standard spray lance length is 0.5m.
 - There is an integrated pressure release and pressure safety valve.
 - The sprayer is fitted with a base ring to aid stability and a useful storage compartment that can hold spare spray tips, o rings etc.
 - Supplied with a shoulder carry strap.

GLOJNSTST	Each	
------------------	------	--

EXTENSION LANCE

Telescopic Lance 1-2 metres for Gloria 5 litre sprayers.

132-0000	Each	
-----------------	------	--

C 2 BAR GLORIA PRESSURE REGULATOR

A 2 bar pressure regulator valve designed to fit the Gloria range of sprayers. The regulator fits between the standard trigger valve and spray lance. The regulator allows the spray output to be accurately controlled by reducing output if the tank pressure is too high and cutting off the flow altogether if tank pressure falls too low. This reduces the risk of over or under spraying.

GLO2BARBLU	Each	
-------------------	------	--

E GLORIA NO. 89 SPRAYER

- The ever popular 1.0 litre (gross capacity 1.45 litre) sprayer.
- The maximum operating pressure is 3.0 bar and the sprayer is fitted with an integrated pressure safety valve.
 - Supplied with an adjustable spray nozzle that gives a variable spray pattern from a hollow cone to a fine jet. The spray nozzle head is fully adjustable on a swivel fitting.
 - The filler aperture is a large diameter for ease of use and the stability of the conical shape is further enhanced by a protective base ring.
 - The sprayer is fitted with Viton seals, weighs 0.75kg and the dimensions are 29.5cm high, 18 cm wide and 16.5 cm deep.

GLO89SPRA	Each	
725800	Seal Kit Each	
726143	Viton seal kit Each	
00-900/CR	Crack and crevice nozzle Each	

SURFACE SPRAYING EQUIPMENT



F

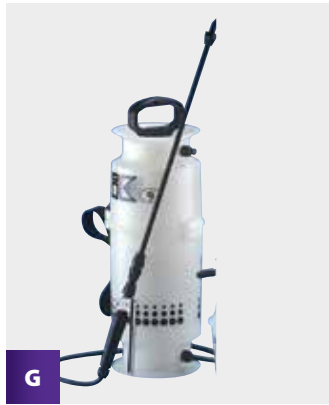

G

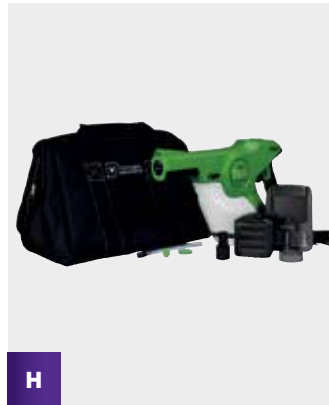

H

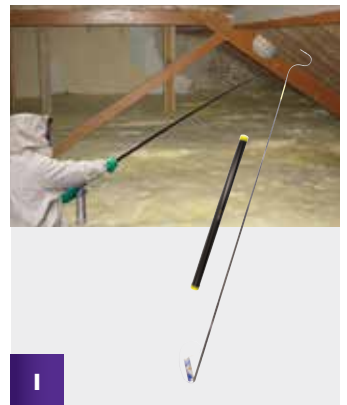

I

F IK MULTI 1 LITRE SPRAYER

The IK MULTI 1.5 sprayer offers a professional spraying solution to achieve optimum results in a wide range of situations. The IK MULTI 1.5 is designed for maximum strength and versatility with the most aggressive chemicals. Supplied with an adjustable nozzle and fan nozzles, other features:

- Safety valve with depressurisation option
- Protective sleeve for valve chamber
- Large opening for easy filling
- Translucent tank with level indicator

IK1.5LSPRAYER

Each

G IK9 - PC SPRAYER

A lightweight sprayer with polypropylene tank featuring

- Pressure regulator
- Viton seals
- Directional lance
- Safety valve
- Cone nozzle & flat fan tip

IK9SPRAYE

6 litre sprayer

H ELECTROSTATIC HAND-HELD SPRAYER

An electrostatic sprayer designed to positively charge any solution sprayed through it. The sprayer electrostatically wraps any solution around objects to provide a 360 degree coating. The sprayer applies up to 65% less solution in comparison to a conventional sprayer. Spray is applied over 300x quicker than a conventional sprayer. Battery powered, Key Features:

- Patented electrostatic charge penetrates chemical providing a thin even spray pattern on all surfaces.
- Weighs only 2.5kg with a full tank.
- Cordless convenience allows for effortless movement room to room.
- 3-in-1 nozzle lets you set the spray particle size to match the application.
- 1 litre refillable tank.
- Victory 16.8v Lithium-Ion battery allows you to run between 20-80 tanks on a single charge.
- Optimum Spray Distance: 2 - 4 feet
- Run Time: 4 hours
- Charge Time: 1.5 hours
- Nozzle Sizes: 40 Micron full cone, 80 Micron full cone, 110 Micron fan

ELECTSPRAYER

Each

I AEROSOL 3

Aerosol 3 is a 3.25m adjustable telescopic lance that attaches to aerosol products such as Digrain Wasp & Hornet Nest Destroyer, Bayer Flying & Bayer Crawling.

- Designed specifically for closer range precision treatment ideal for attics and confined areas.
- Lance has adjustable length of 1 m to 3.25 m.
- Reduces time taken to treat nests.
- Useful in unfloored attics, eliminating the need for walking boards.
- Stores in to a compact 1.3 m long PVC Protective Carry Tube.

AEROSOL3

Each

FOGGING EQUIPMENT

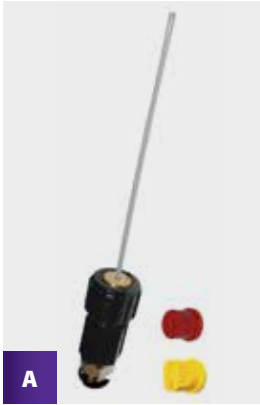

A



B



C



D



E

A AEROSOL 3 NOZZLE KIT

To attach to the Aerosol 3 unit when using with standard aerosols. The nozzle kit includes a crack and crevice nozzle, flat fan spray tip, and a cone spray tip.

AEROSOL3NOZKIT	Each	
-----------------------	------	--

B U240 FOGGER

NEW

The U240 Airofog professional cold fogger is a mains powered portable ULV applicator, with a simple variable flow control and finger operated dial. The U240 has a fogging distance of approximately 12 meters and produces droplets in the 15-30um range. Supplied with a carrying strap, a range of dosage nozzles, service kit and fitted with a 5 meter cable with UK plug. Can be used with oil and water based products.

- Precise controlled fog particle size for maximum efficiency
- Compact ergonomic design
- Separate filling aperture with wide neck for ease of use
- 5L graduated translucent solution tank
- Designed for professional use

U240FOGGER	Each	
-------------------	------	--

C U260 FOGGER

NEW

The U260 Airofog professional cold fogger is a mains powered portable ULV applicator. It has an extendable hose with a simple variable flow control and finger operated dial that allows fogging to be carried out in difficult areas. The U260 has a fogging distance of approximately 12 meters and produces droplets in the 15-30um range. Supplied with a carrying strap, a range of dosage nozzles, service kit and fitted with a 5 meter cable with UK plug. Can be used with oil and water based products.

- Precise controlled fog particle size for maximum efficiency
- Compact ergonomic design
- Separate filling aperture with wide neck for ease of use
- 5L graduated translucent solution tank
- Designed for professional use

U260FOGGER	Each	
-------------------	------	--

D AIROSTAR BATTERY FOGGER

NEW

The AiROSTAR, battery powered ULV Fogging Machine is ideal for use in areas where access to mains power is limited. Fitted with an extendable hose with a simple variable flow control and finger operated dial that allows fogging to be carried out in difficult areas. The powerful 11.6 AH li-ion battery enables the AiROSTAR to run continuously for approximately 1 hour with a charging time of 4.5 hours. The AiROSTAR has a fogging distance of approximately 11 meters and produces droplets in the 15-30um range. Supplied with a carrying strap, a range of dosage nozzles and service kit. Can be used with oil and water based products.

- Precise controlled fog particle size for maximum efficiency
- Compact ergonomic design
- Separate filling aperture for ease of use
- 5L graduated translucent solution tank
- Designed for professional use

AIROSTARFOG	Each	
--------------------	------	--

E CIFARELLI M1200 POWERED KNAPSACK MISTER BLOWER

The M1200 is equipped with a well proven powerful 5 horse power C.7 two-stroke engine. The high performance large diameter fan has an air displacement up to 20 cubic metres per minute, at speeds of up to 280 mph, a variable flow control from 0-4 litres per minute and an effective reach up to 17 metres in calm weather conditions. The M1200 makes an ideal spray applicator for fungicides and insecticides at low volume spray applications where access to the target is limited. By removing two plugs from within the spray tank and installing two outlet pipes the machine is quickly converted from a mistblower to a powder duster. The machine includes a well-padded back support and harness to maximise operator comfort. Typical application – spraying fungicide and insecticide in soft fruit trees/bushes, fruit and salad crops under glass and polythene. Application of disinfectant in and around ventilated buildings, eg poultry houses etc, and autumn leaf blowing.

CIFARELLIM1200		
-----------------------	--	--

T8 FOR LIQUID SPRAYING.

DUSTING EQUIPMENT

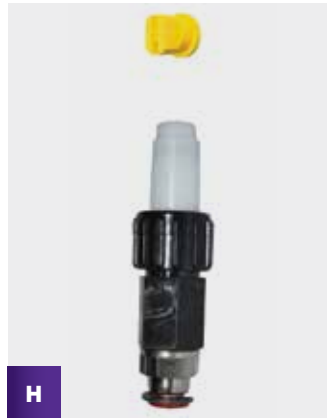

WHEN INITIALLY LAUNCHED THE T8D'S MAIN USE WAS FOR DUSTING. THE PRODUCT CAN NOW BE USED FOR LIQUID SPRAYING. THE PRODUCT CAN BE CONNECTED TO GLORIA SPRAYERS USING THE M11 ADAPTOR.

F T8 S LIQUID CONVERSION KIT

For customers who already own a T8 Dusting Lance (formerly XL8 Dusting Lance). The T8 S Liquid Conversion Kit enables users to convert their existing lance to liquid spraying. All the necessary components are included in the kit. The kit is designed to store inside the spare tube of the T8 Carry case, keeping everything in one convenient case. Supplied with a universal adaptor for use with a wide range of sprayers.

Specification:

- 1 x Pole Section 7 (Tip)
- 1 x Flexi-Tip Kit
- 1 x Compression Fitting 6 mm
- 1 x Hose Kit (Main 8m Hose)
- 1 x Adjustable Cone Spray Nozzle
- 1 x Yellow Flat Fan Spray Tip

T8SLIKIT

Each

G T8 D EXTENSION

The original extension, which needs a separate T8 S Nozzle Kit for use with liquids.

T8DEXTENSION

Each

H T8 S NOZZLE KIT

A push fit fully adjustable cone nozzle that attaches to the T8 D to allow liquid spraying to a working height of 8m. Also supplied with a flat fan nozzle tip.

T8SLIQNOZ

Each

DUSTING EQUIPMENT

I DR5 DUSTER

A 5-8 lbs (2kg-4kg) capacity polythene tank duster incorporating a pump which enables the operator to pressurise the duster without an external power source. Pressure relief valve included, maximum operating pressure 3 Bar. Also available is a special tool that enables easy installation of the brass dip tube after routine maintenance and cleaning

DR5DUSTER

Each

DR5TOOL

Each

DUSTING EQUIPMENT

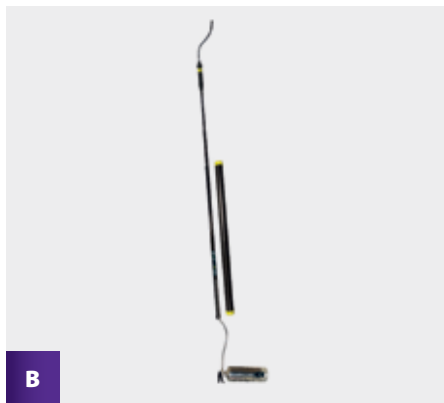
**A AR8 PRO KIT**

A telescopic dusting lance with a working height of 8m. Powered by a 1 litre stainless steel refillable pressure tank which is easily pumped up before use (approximately 25 pump actions required to reach 6 Bar pressure using a common stirrup pump). Supplied with a 35cm flexible nozzle allowing precision application. Can also be filled using a battery powered vehicle tyre inflator pump. Product Description:

- Long and light allowing precision dusting at height.
- Lance is adjustable for working heights between 2m to 8m.
- Reduces time taken to treat nests.
- Reduces the need for access equipment and the risk of injuries due to the elimination of ladder use.
- Reduces risk of stings when treating large or difficult nests that have been disturbed.
- Environmentally friendly, no empty gas cylinders to dispose of.
- Quick and easy to assemble.
- Allows lance to be operated at optimum 6 bar pressure for precision application.

Specification:

- 7 sections, powder chamber and flexible nozzle = 7.15m (to tank connector 8m).
- Lance stores in a compact 1.3m Heavy Duty Carry Case. (lance weight 1.16kg)
- Refillable 1L Stainless Steel compression tank (weight 0.9kg)
- 35cm flexible nozzle is easily bent to the required angle.
- No dust blockages - no powder enters the main tubing system so dust blockages cannot occur here.

AR8PROKIT

Each

B AR3 PRO KIT

A telescopic dusting lance with a working height of 3.15m, designed for close range treatments e.g. of indoor use in attics. Powered by a 1 litre stainless steel refillable pressure tank which is easily pumped up before use (approximately 25 pump actions required to reach 6 Bar pressure using a common stirrup pump). Supplied with a 35cm flexible nozzle allowing precision application. Can also be filled using a battery powered vehicle tyre inflator pump.

Product Description:

- Designed for close range treatments e.g. Inside attics or wasp nests located in air vents etc.
- Useful when treating wasp nests in unfloored attics.
- Environmentally friendly, no empty gas cylinders to dispose of.
- Quick and easy to assemble.
- High quality 1 litre refillable stainless steel compression tank easily pressurised.
- Allows lance to be operated at optimum control pressure of 6 bar for precision application.

Specification:

- 3 sections, plus powder chamber and flexible nozzle = 3.15m.
- Lance stores in a compact 1.25m tough carry tube. (lance + powder chamber combined weight 390g)
- Refillable 1L Stainless Steel compression tank (weight 0.9kg)
- 35cm flexible nozzle is easily bent to the required angle.
- No dust blockages -no powder enters the main tubing system so dust blockages cannot occur here.

AR3PROKIT

Each

C DR5 MINI FLEX TIP

A flexible dusting tool for use with the DR5 Duster and extension lances for difficult to reach spots.

- 50cm flexible length
- 6mm diameter
- Compact, tough and light allowing precision dusting
- Can be bent to almost any shape to allow easy access to restricted areas

DR5FLEXTIP

Each

DUSTING EQUIPMENT

**D T8D EXTENSION FOR DR5 DUSTER**

Long reach 8 metre telescopic extension lance. The ultimate kit for treating wasp nests! Long and light allowing precision dusting at height

- Lance is adjustable at lengths from 1.5m to 8m
- Reduces time taken to treat difficult to reach wasp nests
- Reduces risk of stings when treating large or difficult nests that have been disturbed
- Reduces the need for using access equipment and the risk of injuries due to elimination of ladder use
- T8 D will ensure compliance with the Working at heights (2005) regulations

Specification

- Telescopic fibre glass lance range from 1.5m to 8m
- 7 sections
- Stores into a compact 1.3m long protector case
- Overall weight of 1.5 kg
- Long flexible tip is easily bent to the required angle
- 10 cm Hi-Viz yellow sight tip

T8D EXTENSION

Each

T8DBLOCKTOOL

Unblocking Tool

E ALUMINIUM EXTENSION LANCES

2 different sized rigid aluminium extension lances for use with the DR5 Duster, PA2 Powder Applicator and GPS Gaspot.

04-615

1.5m rigid aluminium lance

O-rings for aluminium extension lances

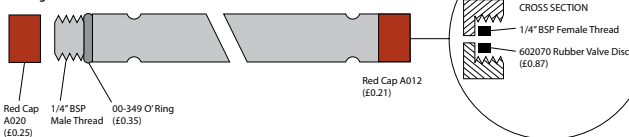
**F LANCE CARRY CASE**

A sturdy carry case that can be used to safely transport aluminium extension lances.

LANCECASE

Each

G STABILISER LANCE SIDE-HANDLE ATTACHMENT

For use with the GPS Gaspot (supplied as standard with each unit) DR5 Duster and Dustick. Enables pinpoint accuracy. Ensures maximum control.

PAS011

Each

H JOINT SUPPORT BRACKET

This bracket helps to support extension lances when joined together.

PAS019

Each

I AR BULB DUSTER KIT

The AR Bulb Duster is a hand duster where the dust is placed in a powder chamber separate from the hand pump. Dust is expelled through a flexible extension pipe by squeezing the hand-held air bulb which attaches to the powder chamber. It has the advantage of the 30cm flexible stay put nozzle of the AR 8 system, and comes supplied with a push fit nozzle for accessing cracks & crevices. The insulated plastic tip enables it to be used for dusting electrical sockets & appliances etc. This is a very useful tool for anyone involved in bed bug treatments.

ARBULB-KIT

Each

AR8 PRO KIT PARTS LIST

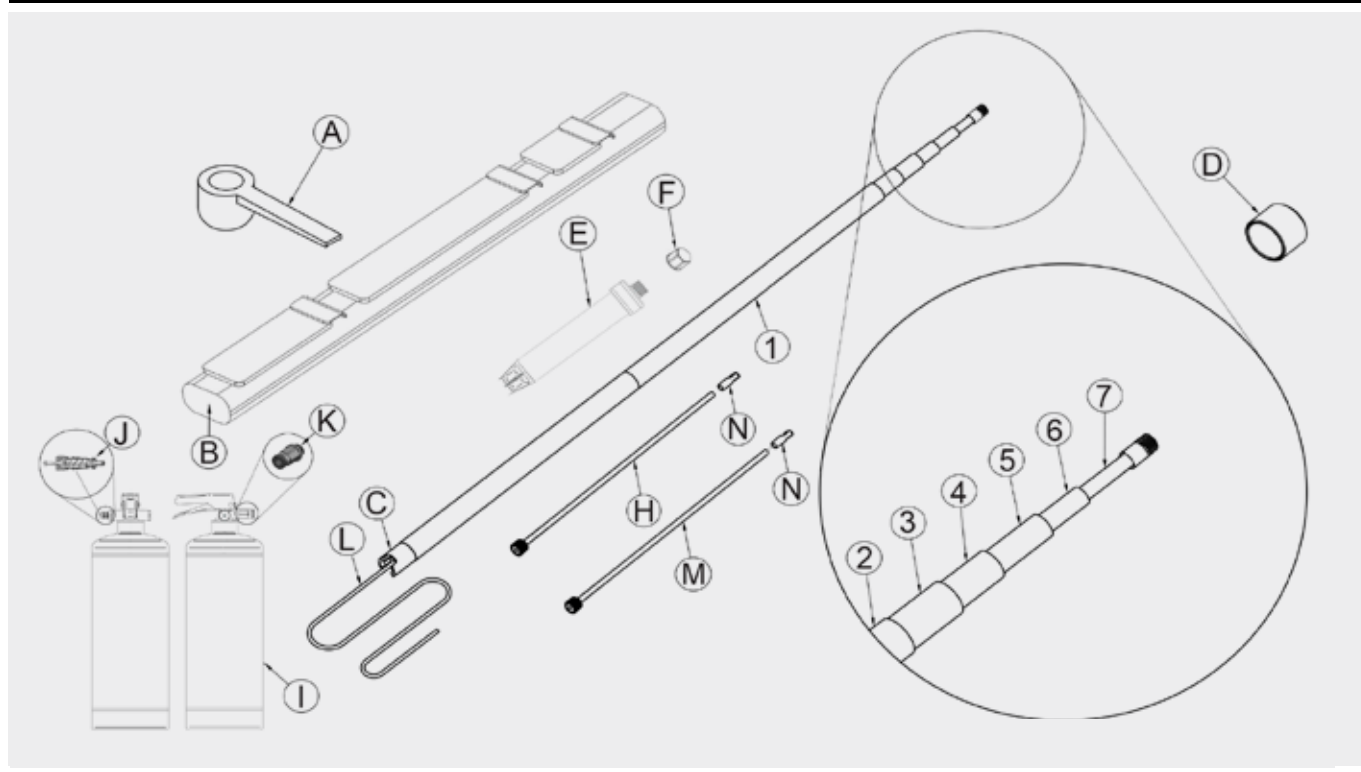

COMPONENT PARTS

KEY	REPLACEMENT PARTS / COMPONENT DESCRIPTION	PART #	PRICE
1	Replacement Pole Section 1 (Base)	AR8-01	
2	Replacement Pole Section 2	AR8-02	
3	Replacement Pole Section 3	AR8-03	
4	Replacement Pole Section 4	AR8-04	
5	Replacement Pole Section 5	ARP-09	
6	Replacement Pole Section 6	ARP-10	
7	Replacement Pole Section 7 (Top)	ARP-11	
A	5g Powder Scoop	PSC00P-01	
B	Heavy Duty Carry Case (Bag only without tubes)	AR38-11	
C	Rubber End Foot	AR8-14	
D	End Cap	AR8-18	
E, F	Replacement Powder Chamber (Inc 1 x cap)	ARP-01	
H, N	Flexible Nozzle Kit - Standard tube size (8 mm Diameter x 35 cm)	ARP-03	
I	1L Stainless Steel Pressure Tank	ARP-05	
J	Inflator valve inner core (Inc fitting tool)	ARP-06	
K	6 mm Compression rush fit outlet valve	ARP-07	
F, N	Powder Chamber and tip cap (2 pcs)	ARP-08	
L	AR 8 Pro Replacement hose Kit (8m)	ARP8-01	

PLEASE NOTE THE ABOVE DIAGRAM IS FOR THE NEW AR8 PRO KIT VERSION.

FOR OLDER PRE 2019 AR8'S PLEASE CONTACT THE KILLGERM® CUSTOMER SERVICE TEAM.

DR5 DUSTER

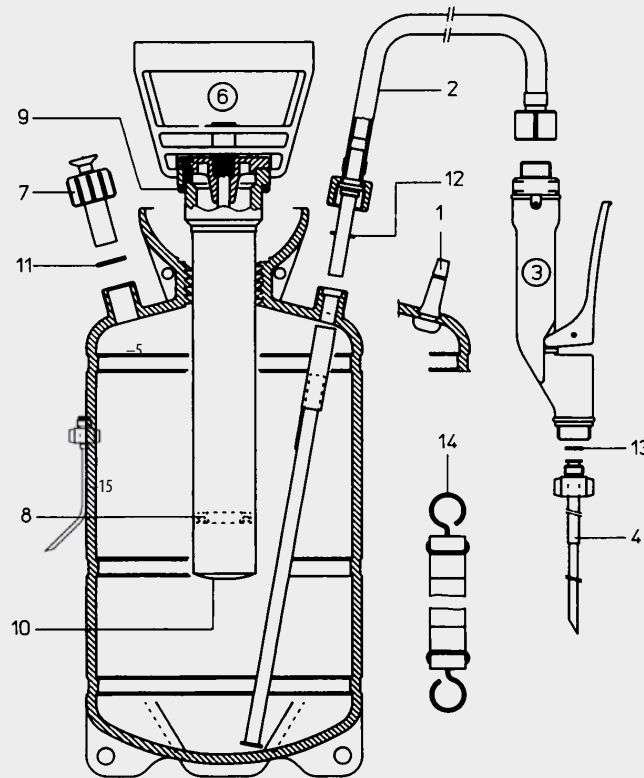
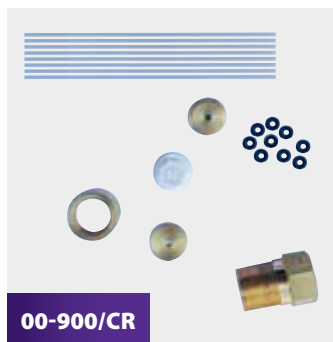
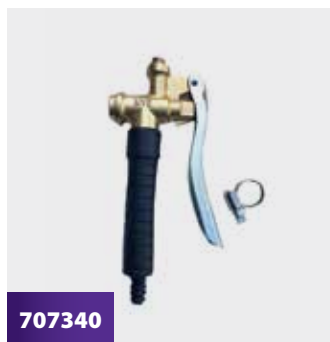

FIG. NO.	DESCRIPTION	PART NO.	PRICE
1	Valve	50137531	
2	Hose complete	11478202	
3	Control valve complete	10495007A	
4	Brass wand	114 22101	
5	Wand connector	11341801	
6	Pump complete	11906301	
7	Pressure relief valve 3 bar	11617901	
*	Gasket set	11629801	
Parts marked with an asterisk only included in this set.			
8*	Sleeve (Pack of 6)	11642701	
9*	O-ring 50.16 x 5.34		
10*	Valve gasket		
11*	Gasket 21/15.4 x 2		
12*	Gasket 15/5.5 x 2		
13*	Gasket 11.9/7 x 1		
14	Shoulder-strap	10453601	
15	Crack & crevice tip	11435001	
	DR5 Maintenance Tool	DR5TOOL	

GLORIA 5 LITRE PARTS LIST

PART #	DESCRIPTION	PRICE
710240	Pump Assembly Complete	
707270	Complete Seal Kit	
707340	Trigger Valve Complete	
701310	Lance tube with washer	
00-605/OR-G	Hose complete with ends	
704050	Variable Spray Nozzle	
00-900/02	Flat Fan Nozzle	
02-347/02	Flat Fan Yellow Tip	
00-900/CR	Crack & Crevice Nozzle	
723840	Pressure Gauge	



EXODUS® PARTS DIAGRAM

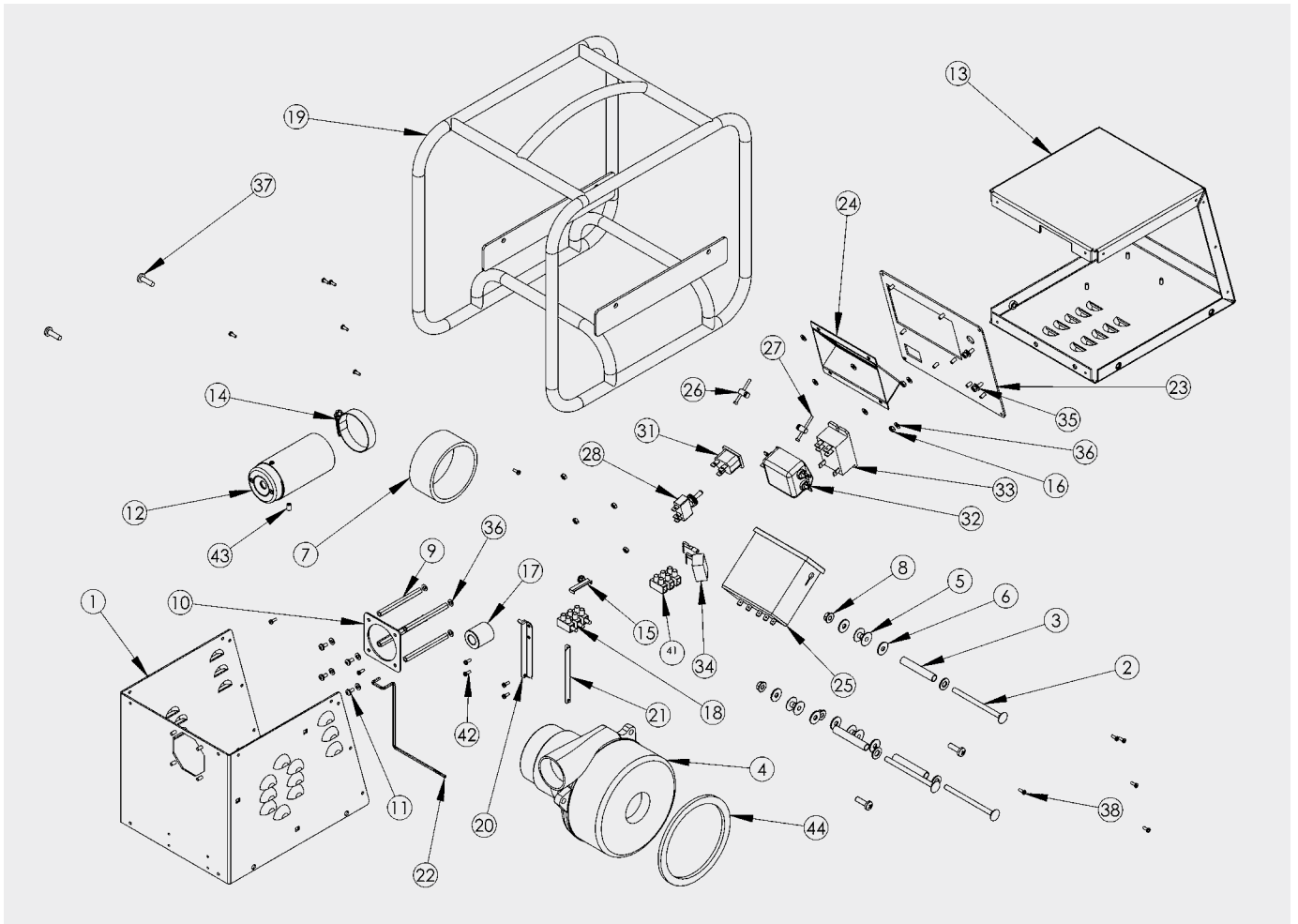

COMPONENTS LIST			
KEY	DESCRIPTION	PART #	QTY
1	Front Panel	MEXDFRNTP	1
2	Coach Bolt M6 X 90Mm	FSC6901	3
3	Spacer 57.5Mm	MEXDSPACER	3
4	Motor Assembly	EEXDMOTOR230	1
5	Shoulder Washer Nylon	WASHNYLSHLDR	6
6	M6 Washer 18Mm Od St.st	FWA607	6
7	Motor Hose	PEXDMTRHOSE	1
8	M6 Flange Nut	FFN609	3
9	M4 X 75Mm Stand Off	STDOFFM4X75PLD	4
10	Nozzle Plate	MEXDNOZP	1
11	M4 X 8Mm Pozi Pan Screw St.st	FSC4201	4
12	Nozzle Assembly	ANOZLEEXD	1
13	Rear Panel	MEDREARP	1
14	Jubilee Clip 45-60Mm Zinc Plated	FSWD40/60B	1
15	Flat Tie Holder Fth-11-8-01 Richco	TWNYLHLD	1
16	M4 Nyloc Nut St.st	FNT401	11
17	Ferrite	EFERRITEEXD	1
18	Conn Block Male	ETEMAI12M	1
19	EXODUS FRAME	MEXDFRAMESLV	1
20	Bottle Bracket A	MEXDBOTBA	1
21	Bottle Bracket B	MEXDBOTBB	1
22	Bottle Lever	MEXDBOTLVRSS	1
23	Control Panel	MEXDCNTLP	1
24	Timer Housing	MEXDTIMRH	1
25	Timer	EEXDTIMER230	1
26	Timer Mounting Lug	N/A	2
28	Toggle Switch 3 Position	ESWITCH3	1
31	Iec Inlet Black	ETEMA11X/A	1
32	Schaffner Filter	EFILTEREXD	1
33	T92p7a22-240 Relay 240Vac 30A	ERELAYDPN0230	1
34	Rifa Capacitor	ECAPACEXD	1
35	M5 Plain Washer	FWA502	2
36	M4 Shakeproof Washer St.st	FWA401	23
37	M6 X 20Mm Pozi Pan Screw St.st	FSC6601	4
38	No6 3/8" Pozi Pan Self Tapper Black	FSC6002	18
39	M8 Washer 16Mm Od Bzp	FWA807	3
41	Conn Block Female	ETEMA112F	1
42	No6 2/8" Pozi Pan Self Tapper St.st	FSC6001	4
43	Tygon Seal	C-140	1
44	Motor Gasket Exul/104A	PEXDMTRGSK	1

FULL FACE MASK & HALF MASK RESPIRATORS



A SUNDSTRÖM SR200 FULL FACE MASK RESPIRATOR



The Sundström SR200 Class 3 full face mask respirator is designed to the highest standards with both protection and comfort in mind

- Manufactured in silicone, the one size mask fits most faces
- Integrated inner mask enhances comfort as there are no joints
- Low breathing resistance
- Polycarbonate scratch - resistant visor
- Large field of vision
- Lightweight, only 450 grams

Approved to Class 3 as per EN136:1995. Visor tested against EN166:1998.

Adaptor included allowing use with Sundström filters

SUNDFULLMASK Each

B SUNDSTRÖM FULL FACE MASK ADAPTOR



Enables the Sundström filter range to be used on a full face mask respirator. Please note that the Sundström filter range can be fitted to the CK1100 full face mask when using this adaptor.

SUNDFULLAD Each

C SUNDSTRÖM FREEFLOW HALF MASK RESPIRATOR



The FreeFlow half mask, developed by Sundström, has been designed to deliver high levels of comfort and protection while offering superb value for money. Elasticated head harness for a comfortable and secure fit. The FreeFlow half mask utilises the Sundström filter range.

Approved to EN140:1998

SUNDHALFMASK Each

D PPE PLASTIC CARRY CASE



Plastic carry case with webbing strap suitable for storage/carriage of respirator, filters, gloves etc.

Approximate size 150mm x 185mm x 260mm.

PPECARRYC Each

PARTICLE FILTERS FOR HALF MASKS AND FULL FACEMASKS ARE GRADED INTO THREE CLASSES

Filter class	Protects against	Collecting efficiency (NaCl, paraffin oil) dry particles wet particles
P1	Solid and wet particles ¹	80%
P2	Solid and wet particles ²	94%
P3	Solid and wet particles ³	99.95%

¹ Not against liquid aerosols, carcinogens and radioactive substances, microorganisms (bacteria, viruses, spores) or biochemical substances (enzymes, hormones).

² Not against microorganisms (viruses, spores) or against biochemical substances (enzymes, hormones).

³ Protects against all types of particles.

A filter of one class also covers the classes below it, i.e. P3 also covers P1 and P2.

Change the filter if it has been damaged or if you feel increased breathing resistance.

Particle filters protect only against particles.

FILTERS FOR FULL FACE AND HALF MASK RESPIRATORS



E



F



G



H

- Interchangeable filters for protection against combined hazards.
- The following range of filters are suitable for use with both the Sundström half and full face masks. Wherever dust and gases occur at the same time, filters can be combined. Any dust filter can be easily fitted on to the front of any gas filter.
- Please note that the Sundström range of filters can be fitted to the CK1100 full face mask respirator with the use of the Sundström full face mask adaptor.

E SUNDSTRÖM A1 FILTER



For organic vapours and gases with a boiling point above 65°C.

SUNDFILA1

Each

F SUNDSTRÖM P3 FILTER



Highly efficient dust filter. Can be easily fitted on to the front of any Sundström gas filter to produce a combined filter.

SUNDFILP3

Each

G SUNDSTRÖM ABE2 FILTER



For organic, inorganic and acid gases and vapours.

SUNDFILB2

Each

H SUNDSTRÖM ABEK FILTER



For organic, inorganic, acid and ammonia gases and vapours.

SUNDFILABEK

Each

GAS FILTERS ARE GRADED INTO CLASSES AND TYPES

Filter class	Tested in concentrations of up to:	Filter type	Protects against	Colour code
1	0.1 percent by volume = 1 000 ppm	A	Organic gases/vapours, e.g. solvents such as white spirit and toluene	Brown
2	0.5 percent by volume = 5 000 ppm	B	Inorganic gases/vapours, e.g. chlorine, hydrocyanic acid, hydrogen sulphide	Grey
3	1.0 percent by volume = 10 000 ppm	E	Acid gases, e.g. sulphur dioxide	Yellow
		K	Ammonia and certain amines	Green

ppm= part per million.

After saturation, leakage will occur at an accelerating rate. The filter should be changed in good time before saturation. Use only filters from unopened packages.

Gas filters protect only against gas/vapour.

DISPOSABLE RESPIRATORS

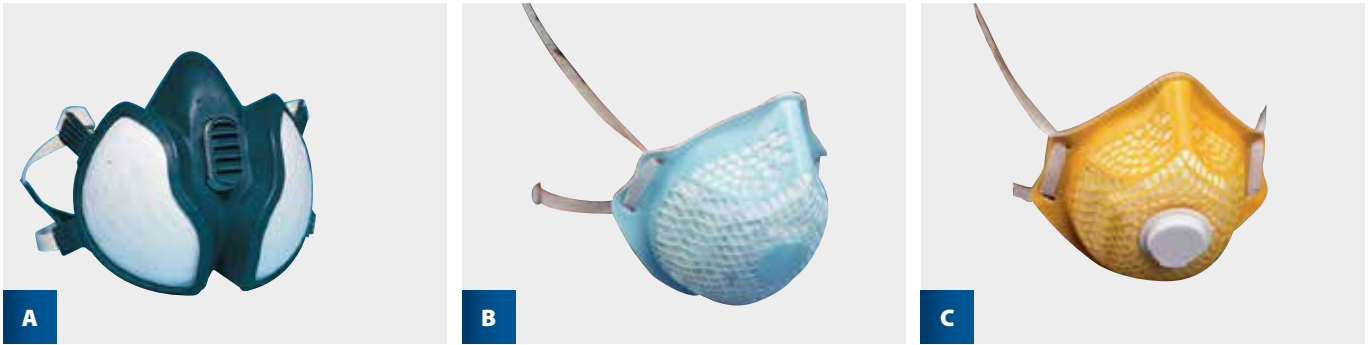

A 3M 4255 RESPIRATOR (A2P3) CE

The 3M respirator can provide protection against a range of organic vapours boiling above 65°C (with good warning properties, i.e. taste or smell) in concentrations up to 10 times the Occupational Exposure Limit (OEL) or 5,000ppm, whichever is lower. In addition, this respirator can protect against fine dust, with mean particle size down to 0.5 micron, in concentrations up to 20 times OEL. The 3M 4255 respirator meets the requirements of the HSE approved standard EN405 FFA2P3. Please note this respirator has a limited service life. It should therefore be replaced immediately upon first sign of 'breakthrough' (i.e. when contaminants can be detected by taste or smell inside the respirator) or within one month of issue, whichever occurs first.

3MRESP Each

B DISPOSABLE P2 MASKS CE

Completely metal-free respirator featuring latest filter technology for reduced breathing resistance. Offers protection against non-toxic dusts and oil/water based mists.

- Mesh shell helps retain shape and prevents collapse onto the face
- Nose clip free: preformed shape removes need for regular adjustment
- Fully adjustable head strap enhances excellent fit
- Blue coloured mesh denotes FFP2

At the time of printing, these disposable masks were unavailable. We are hopeful they will be back into stock early 2021. Please contact our Customer Services Team to check what is available.

DISPFFP2 Pack of 20

C DISPOSABLE P3 MASKS CE

Completely metal-free respirator featuring latest filter technology for reduced breathing resistance. Offers protection against non-toxic dusts and oil/water based mists.

- Mesh shell helps retain shape and prevents collapse onto the face
- Exhalation valve reduces temperature and humidity within the respirator: low profile aids field of vision
- Nose clip free: preformed shape removes need for regular adjustment
- Fully adjustable head strap enhances excellent fit
- Orange coloured mesh denotes FFP3

At the time of printing, these disposable masks were unavailable. We are hopeful they will be back into stock early 2021. Please contact our Customer Services Team to check what is available.

DISPFFP3 Pack of 5

DISPOSABLE RESPIRATORS

	FFP1 RESPIRATORS	FFP2 RESPIRATORS	FFP3 RESPIRATORS
PROTECTION FACTOR	APF 4	APF10	APF20
TYPICAL APPLICATIONS	Low levels of fine dust (up to 4 x WEL) and oil or water based mists	Moderate levels of fine dust (up to 10 x WEL) and oil or water based mists	Higher levels of fine dust (up to 20 x WEL) and oil or water based mists

Classification Explained.

When correctly used by a wearer who has passed a face fit test, an **FFP1** respirator should reduce exposure to airborne particulates by a factor of 4, an **FFP2** by a factor of 10 and **FFP3** by a factor of 20.

FIRST AID KITS



D

HAND PROTECTION



E



F

COVERALLS



G

D VAN AND TRUCK KIT

- Statutory cover for drivers of vans and trucks.
- Steriflow eyewash buffer solution can be used if the eye is splashed with acid or alkali, forming a barrier between the surface of the eye and the foreign substance.
- Kit housed in an ABS box.
- Designed for quick and easy access. Comes with integral wall bracket for mounting inside the vehicle.

KITVAN	Each	
--------	------	--

E TOUCH N TUFF (POWDERED) TO EN 374



The Touch n Tuff gloves are also available in a powder free version;

TNTPF-M	Medium	Box of 100 (Powder Free)
TNTPF-L	Large	Box of 100 (Powder Free)
TNTPF-XL	X-large	Box of 100 (Powder Free)

F SANI-GARD NITRILE GLOVES/100 PIECES

NEW

Sani-Gard are latex-free synthetic disposable glove made from a proprietary blend of vinyl and nitrile. This powder-free glove has a superior fit compared to vinyl gloves.

- Extra strong, Vinyl & Nitrile mix, Chemical resistant
- Non Sterile, Tested to EN ISO 374-5:2016, Beaded cuff, Suitable for food industry use
- Sizes available: Small – Extra Large

SANIG	Each	
-------	------	--

G TYVEK® 600 PLUS COVERALLS TYPE 4, 5 & 6



The Tyvek® 600 Plus Coverall offers protection against type 4,5 and 6. The garment design offers ease of movement to the wearer, while the hood and elastic around the hood are designed for tight fit around a full face respirator. The seams are stitched and overtaped, offering equal barrier as fabric. **Recommended for use when cleaning up bird guano.** Available in white.

TYVEK600-M	Medium (36-39.5")	
TYVEK600-L	Large (39-42.5")	
TYVEK600-XL	Extra large (42-46")	
TYVEK600-XXL	Extra, extra large (45.5-49")	

HEALTH & SAFETY



A

B

A KILLGERM® NILAQUA INSTANT HAND SANITISER

Killgerm Hand Sanitiser (Nil aqua) is an alcohol-free, quick drying hand sanitiser that offers post application protection for up to 6 hours. Based on two active ingredients, Didecyl Dimethyl Ammonium Chloride and Quaternary Ammonium Compounds, it Kills up to 99.9999% of germs, including Coronavirus, MRSA, C-diff, Norovirus and more. Killgerm Hand Sanitiser (Nil aqua) is non-skin drying and non-skin irritating. EN1500 approved product (Hygienic Hand Rub test - pass).

NILAQUA7X100 7 x 100ml

B ANTI BAC GORILLA HAND WIPES

NEW

Gorilla Wipes are pre-impregnated cleaning wipes designed primarily for use by anyone who needs a fast and effective hand cleaning product. No further need for dirty wet towels, messy liquid cleaners or water. This a true all round multi purpose cleaning solution for most types of stains and dirt.

They are truly unique in their ability to clean general grime, oil and grease. They are also a wonderful multi purpose degreaser which makes them great for cleaning around cookers and for messy jobs such as pest control.

The new Anti Bac formula kills 99.9% of harmful bacteria including *Leptospira ictero-haemorrhagie* and is certified to BSEN1276:1997 standards and are proven to be effective against 99.9% of most common germs, bacteria and viruses.

Wipe size: 20cm x 30cm

GORILLAPK80 Pack of 80

CHEMICAL STORAGE



D



E



F



G

D PESTICIDE CARRY BAG

An updated pesticide carry bag made from nylon with PVC coating. Features include side pocket, end pocket with polypropylene webbing, shoulder strap, re-inforced PVC base, covered baseboard and insert with separate compartments.

PESTBAG2 Each

E PESTICIDE JARS

A see-through jar that holds approximately 1.75 kilos of rodenticide bait.

PESTJAR Each

F CHEMLOCK DUAL BOX

Made from specifically formulated thermoplastic to be super strong and chemical resistant.

The compound provides a wide spectrum of chemical resistance. A permanent bond is achieved using a replaceable high ACN nitrile rubber seal selected for its high resistance to chemicals. Designed to take into account the Professional Operator working with Aluminium Phosphide.

External Dimensions: 560mm x 390mm x 425mm

Box Carrying Capacity: 55 Litres

CHEMDUAL Each

G CHEMLOCK PEST PARTNER BOX

Made from specifically formulated thermoplastic to be super strong and chemical resistant.

The compound provides a wide spectrum of chemical resistance. A permanent bond is achieved using a replaceable high ACN nitrile rubber seal selected for its high resistance to chemicals. Designed to take into account the Professional Operator working with Aluminium Phosphide.

External Dimensions: 350mm x 154mm x 120mm

Total Capacity Approximately: 6 Litres

CHEMPESTPART Each

BEEKEEPERS CLOTHING



A



B



C



D



E

A BEEKEEPERS GLOVES

A leather glove with elasticated polycotton gauntlet to go over the sleeve with a tag for easy pull out action.

	SIZE		
BEEGLOVE8	8	Pair	
BEEGLOVE9	9	Pair	
BEEGLOV10	10	Pair	
BEEGLOV11	11	Pair	

B BEEKEEPERS HAT & VEIL

With two stainless steel rings to stop the net blowing on to the face.

BEEKEEPER	Each	
------------------	------	--

C BEEKEEPERS JACKET (STANDARD VERSION)

Similar to the above, but instead of the hat, there is a flat top. Some beekeepers wear a flat cap underneath it for superior protection.

BEEKEEPES	(Up to 44")	Each	
------------------	-------------	------	--

D BEEKEEPERS JACKET (DELUXE VERSION)

With built in hat and two stainless steel rings to keep bees and wasps well away from the face, but with zipped throw back hood for ease of driving etc. Elasticated at waist and sleeves. On the deluxe version only there are loops on the sleeve ends that go round the thumb inside your glove to maintain a sleeve seal.

BEEKEEPDEL-S	Small (Up to 36")	Each	
BEEKEEPDEL-M	Medium (Up to 44")	Each	
BEEKEEPDEL-XL	Extra Large (44" onwards)	Each	

E BEEKEEPERS TROUSERS

Makes a full suit when used with the beekeepers jackets. Elasticated waistband and ankles.

BEETROU-S	Small (34" Waist)	Pair	
BEETROU-M	Medium (38" Waist)	Pair	
BEETROU-L	Large (42" Waist)	Pair	

BEEKEEPERS CLOTHING



F



G



H

F SENTINEL BEEKEEPING JACKET

A high quality grey beekeeping jacket offering greater protection than conventional beekeeping clothing.

- Ventilated breathable material helps keep you cool
- Excellent visibility through clear view veil
- Lightweight, comfortable & practical to wear
- Velcro fastening cuffs
- Mobile phone breast pocket with zip fastening
- Two lined hive tool pockets
- Dual security at the neck junction
- Durable YKK zips
- Machine washable

SENTJACKET-M	Medium (Up to 54")	Each	
SENTJACKET-L	Large (Up to 56")	Each	
SENTJACKET-XXL	XXL (Up to 60")	Each	

G ALL-IN-ONE HEAVY DUTY BEEKEEPERS SUIT

A high quality grey fabric all-in-one suit developed to meet stringent performance criteria. Extremely durable and hardwearing and retains its smart appearance after multiple laundering. The suit has been designed and tested with pest control in mind. Features include:

- Hood fitted with large net to increase field of vision
- Detachable Hood
- Full Zip Front
- Two large front thigh pockets, along with a mobile phone pocket
- Sleeve hems elasticated and fitted with thumb loops

BEEsuit-M	Medium (40" - 42" Chest)	Each	
BEEsuit-L	Large (44" - 46" Chest)	Each	
BEEsuit-XL	Extra Large (48" - 50" Chest)	Each	

H BEEKEEPERS CLOTHING HOLDALL

A specially made holdall for storage of beekeepers clothing. Measuring 17" in diameter and 5" wide it is perfect for all the various beekeepers clothing. Constructed from 480d navy poly PVC coated material.

BEEKEEPERBAG	Each	
---------------------	------	--

INSPECTION PRODUCTS

NEW



A



B

NEW

A SUPER CAM WIRELESS INSPECTION CAMERA

Wireless inspection camera for easy inspection of hard to reach areas. Compatible with Android and IOS systems. Kit includes a carry case, and a range of useful attachments including a telescopic 1 meter pole, hook and magnet attachment, and flexi rod / gooseneck adapter.

- Built-in Wi-Fi hotspot.
- Wireless range up to 20m [in line of sight].
- Always up viewing mode, the image stays the right way up even when the camera rotates.
- Digital pinch zoom.
- Auto / manual focus.
- Adjustable light.
- Fully charged in 60 minutes type-C USB quick-charge.
- Non-contact voltage detector with audio and visual alerts [50 - 1000V AC].
- Dustproof and waterproof [IP67].

SUPERCAM6.5 Each

B SEESNAKE MICRO CA-150

After introducing the SeeSnake® micro™ - the world's first handheld inspection camera – RIDGID® once more sets the standard for inspection camera's with the new micro CA-150. Features: • Larger LCD Screen (3.5") • 360° Image Rotation • 4 LED Lights • Imager Head - 17 mm / Aluminium • 90cm Cable Extension Available

SEESNAKEM	Each
SEESN90CM	90cm Extension
BATTERYAA	Pack of 10 AA Batteries

INSPECTION PRODUCTS



C

C MOTION SENSOR CAMERA

The Motion Sensor Camera offers the exceptional ability of recording real time videos of pest activity such as rodent activity in an infested area. It allows the operator to confirm the presence of pests and identify the source of an infestation. By inserting a SIM card, the MMS/GPRS function allows the operator to obtain images directly to their smartphone or computer when the camera detects movement.

Key features:

- 2G/GSM SIM card reader - Insert SIM card and receive pictures via MMS and/or E-mail
- Adjustable image resolution 5/8/12 MP Camera
- Video resolution 1080p
- Photo or Video (colour)
- Night mode (Black and White)
- Built in 2.0" LCD screen
- 3 Motion Sensors
- Trigger speed 0.3 seconds
- Compatible with Micro SD card's up to 32gb (**Not supplied**)
- TV out, USB input, MicroSD card input
- Waterproof IP65 rated
- Requires 8 AA Batteries for Camera power supply (**Not supplied**)

Please note no SIM card is supplied with the product.

SENSORCAM4	Each	
SENSOR32GB	32GB Micro SD Card	
BATTERYAA	Pack of 10	

D TC7 TELESCOPIC CAMERA

The TC 7 is a telescopic lightweight lance with an adjustable length from 1.5m to 7m for domestic, commercial and industrial use.

- High quality camera
- USB Mini torch for dark areas
- Strong flexible neck
- Heavy duty carry case
- Video Recording up to 3.5 hours
- Supplied with a 4GB SD card

TC7CAMERA	Each	
------------------	------	--



D

ACCESSORIES

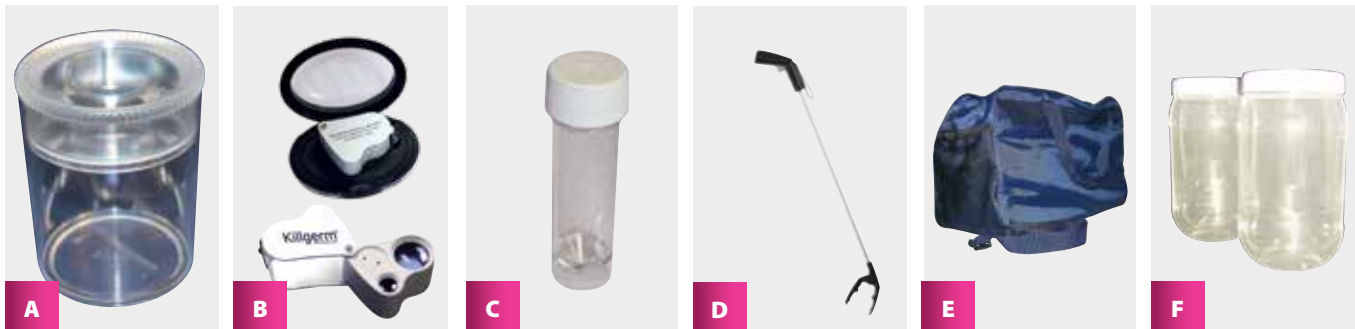
**A KILLGERM® INSECT VIEWER**

Consists of a clear plastic container with screw top magnifier giving 4.75x magnification. Ideal for live insect pest identification. Measures approx 70mm x 50mm diameter.

INSECTVIEW Each

B KILLGERM® LED HAND LENS

The Killgerm LED Hand Lens is a small compact twin magnification hand lens offering 30x and 60x magnification. The two LED's make it ideal for use in areas of low ambient light where on the spot insect id may be required. This compact lightweight lens can be attached to a keychain or lanyard and comes supplied with a hard-shell carry case.

LEDHANDLENS Each

C INSECT SPECIMEN POTS

Ideal container to store insects in preparation for identification.

INSECTPOT20 Pack of 20

D LITTER PICKER

Grip 'n' grab picker with patented sure-grip jaws for a precision pick. Reaches 1.5 metres and picks from 1 gram up to 1 kilo. Lightweight design with easy trigger action.

LITTERPICK Each

E PESTICIDE CARRY BAG

A pesticide carry bag made from nylon with PVC coating. Features include side pocket, end pocket with polypropylene webbing, shoulder strap, re-inforced PVC base, covered baseboard and insert with separate compartments.

PESTBAG2 Each

F PESTICIDE JARS

A see-through jar that holds approximately 1.75 kilos of rodenticide bait.

PESTJAR Each

ACCESSORIES

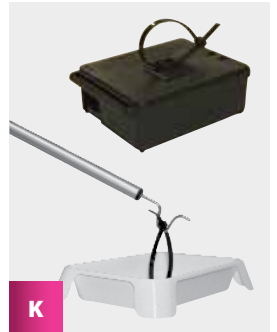

G B & G CARRYING CASE

Holds B & G equipment and sufficient insecticide for an operator's daily needs. Leak proof and lockable. 42cm wide x 35cm deep x 48cm high.

B&GCARRYC	Each	
----------------------	------	--

H AF® POWDER SCOOP

The AF Powder Scoop has been designed to allow the easy filling of a wide range of dusting equipment. This useful tool, made from polypropylene, helps to reduce the exposure time to insecticidal powders and reduces waste from spilt powder. It can be used as a traditional scoop for larger dusting application equipment or as a combined scoop/funnel for use with smaller powder application tools.

AFPOWSCOOP	Each	
-------------------	------	--

I A5 REPORT PADS

Handy A5 inspection pads showing type of visit, inspection findings, action/treatment details and recommendations. Contain 50 sheets of self-carbonating paper to provide professional reports quickly and easily.

REPPADA5	Pack of 50	
-----------------	------------	--

J A4 REPORT PADS

Handy A4 inspection pads showing type of visit, inspection findings, action/treatment details and recommendations. Contain 50 sheets of self-carbonating paper to provide professional reports quickly and easily.

REPPADA4	Pack of 50	
-----------------	------------	--

K AF® TELESCOPIC BAIT ROD

The Telescopic Bait Rod can be used to place and retrieve baits/snap traps in hard to reach places, such as un-boarded loft spaces, roof voids, subfloor areas or to the rear of machinery. The bait rod reduces the need for ladders, crawler boards and other access equipment making it safer, easier and less time consuming for the pest control technician. The pole has 5 adjustable sections which can be locked and unlocked with a simple twist action. The telescopic design allows extension to any length up to 2.5 meters. Stick on clips and cable ties need to be purchased separately. Dimensions: Collapsed 0.55m, fully extended 2.5m.

AFTELBAITROD	Rod only	Each	
AFTELCLIP	Adhesive clips	Pack of 100	
AFTELCABLE	Cable ties (200mm x 4.8mm)	Pack of 100	

ACCESSORIES

**A AA BATTERIES**

Professional AA Alkaline Batteries

- Battery Voltage:1.5V
- External Diameter:14.5mm
- External Height:50.5mm

BATTERYAA Pack of 10

B AAA BATTERIES

Professional AAA Alkaline Batteries

- Battery Voltage:1.5V
- External Diameter:10.5mm
- External Height:44.5mm

BATTERYAAA Pack of 10

C C CELL BATTERIES

Professional C Alkaline Batteries

- Battery Voltage:1.5V
- External Diameter:26.2mm
- External Height:50mm

BATTERYC Pack of 10

D D CELL BATTERY

Professional D Cell Alkaline Battery

- Battery Voltage:1.5V
- External Diameter:34.2mm
- External Height:61.5mm

BATTERYD Each

E CARTRIDGE CUTTER

Simplify the handling of silicon cartridges with this cap and spout trimmer. It saves time and reduces the risk of injury from open blades.

KGA001 Each

ACCESSORIES

NEW



F



G

NEW

F GLORIA MULTIJET WASHER

The Gloria 18v MultiJet is a battery powered pressure washer. The operating pressure can be regulated between 2.5 and 24.9 bar. The MultiJet can draw water from any source (bucket, water butt, bottle or tap). Powered by a 4Ah battery (supplied separately), this pressure washer is ideal for guano removal from balconies/ledges or just general cleaning of bins, bin areas and vans. The foam set can be used to create a foam to aid in general cleaning /disinfection.

Please note both the battery and charger need to be purchased separately.

- Variable pressure regulator. • Max. pumping capacity 24.9 bar. • Draws liquid from any source. • 4-in-1 multifunction nozzle.
- Incl. 40 cm extension lance. • Weight 1.9 kg. • Foam Set Attachment.

GLOWASHMULTI	Multijet Unit and Foamer	
GLOWASHBAT	4.0Ah Battery	
GLOWASHCHA	Standard Charger	

G RINSEKIT POD

Easily rinse 2 people from head to toe or mist the team during a hot day. Rinse off after surfing, running, biking, or any activity. Wash your pets, clean the kids, and keep your gear clean and working well.

- 1.75 gallon tank designed to store pressure for up to a month
- Quickly fills with hot or cold water in 30 seconds from a hose bib or sink
- Easy reach 6ft long hose
- 5 spray settings for all your rinsing needs (Jet, Mist, Center, Flat, Shower)
- Included Hot Water Sink Adapter allows you to fill your RinseKit with hot water from your sink!
- Dimensions: 14 x 8.5 x 11.75 inches

RINSEKIT	Each	
-----------------	------	--



Killgerm®

You know when
you're in safe hands!

www.killgerm.com

AF[®] Range

Killgerm[®] are proud to
present our exclusive range
of AF[®] products

Manufactured by experts for use by professionals

TORCHES

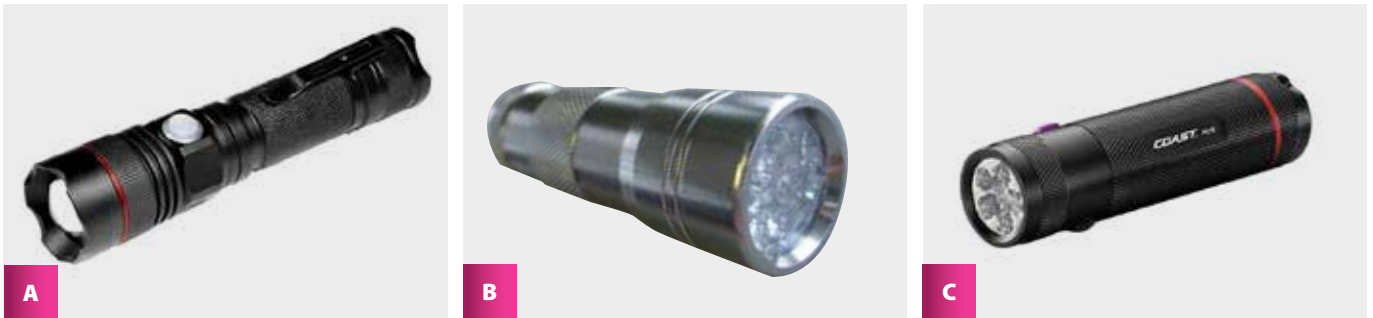

A CLUSON AB200 LED TORCH

A powerful, pocket sized torch with adjustable beam. 500 Lumens, providing a 300metre beam. Fitted with an everlasting LED – no replacement bulbs needed. Fully adjustable from spot to flood, weighing 115g with battery. Made from high grade aluminium, and supplied with a rechargeable li-ion battery.

CLUAB200LED Each

B UV TORCH

Compact, durable UV Torch for use with fluorescent baits. With 12 LED's. **Supplied with 3 AAA batteries.**

UVTORCHLED12 Each

BATTERYAAA Pack of 10 AAA batteries

C COAST PX10 LED UV TORCH

The Coast PX10 is a compact, professional use torch that can tap into a spectrum of light most other torches can't access. Using a total of six LED's; three of which craft a bright white flood beam, while the other three are UV LED's that can form into a precision spot of Ultra Violet light. The White or UV lamps are activated by an independent push button switch, saving you time cycling through the lighting modes.

- Operating Modes: Off / On
- Luminous Flux: 59 lumens (white LED's only)
- LED: 3 x white LED / 3 x ultra violet LED
- Wavelength: 395 nm UV-A (UV LED's only)
- Beam Range: 39 m
- Overall Length: 100 mm
- Weight: 86 grams (including batteries)
- Body Material: Aircraft grade aluminium
- Batteries Required: 3 x AAA (included)

COASTPX10UVLED Each

Anticoagulant rodenticides:

FIRST GENERATION

Warfarin • Coumatetralyl

Warfarin

The first of all anticoagulants to be produced. Whilst it has been replaced by alternatives in some areas due to resistance, it remains a potent rodenticide in many situations.

Coumatetralyl

A potent alternative to Warfarin, with lower risks of secondary poisoning compared to second generation products.

SECOND GENERATION

Difenacoum • Bromadiolone • Difethialone • Flocoumafen • Brodifacoum

Difenacoum

Difenacoum was the first second generation compound for warfarin-resistant rodents.

Bromadiolone

Bromadiolone is a second generation compound for warfarin-resistant rodents.

Difethialone

Difethialone is the first new anticoagulant ingredient to be introduced to the UK in over 20 years. An effective single feed solution to rodent problems.

Flocoumafen

Flocoumafen has a high toxicity to both rats and mice and it can be used as a single feed solution.

Brodifacoum

A highly potent anticoagulant. Effective on both rats and mice with a low single feed required.

ACUTE RODENTICIDES

Alphachloralose

This is a narcotic and acts by slowing down the metabolism of the rodent resulting in death by hypothermia. It is therefore most effective at temperatures below 16°C. It is only approved for use against the house mouse. Underdosing can lead to sub-lethal poisoning and subsequent bait shyness.

Cholecalciferol

A novel mode of action to the anticoagulants. An effective resistance breaker against rats and mice.

CONSULT SPECIFIC PRODUCT LABELS / INFORMATION REGARDING AREAS OF USE E.G. INDOOR USE ONLY, IN AND AROUND BUILDINGS, INDOORS AND OUTDOORS, AND OPEN SPACES.

Rodenticide formulations

Edible Baits

Loose cereal baits, pellets, wax blocks and pasta bait.

Loose cereal baits and pasta baits, by and large, are probably better accepted by rodents. However, in many situations the use of blocks can be advantageous. They are often less susceptible to mould growth and hence remain palatable longer, particularly in damp conditions. They are looked upon favourably by the food industry, with less risk of contamination. Most blocks have a central hole enabling them to be secured, avoiding loss.

Edible Gels, Wax Baits and Pastes

Non-spill formulation especially useful in sensitive environments, such as where food is handled or stored. Edible gels, wax baits and pastes maintain their form and palatability over prolonged periods provided they are kept free from dust and moisture contamination.

Contact Foam

Water-based formulation. Rats and mice contact the foam and ingest it via grooming.

Liquid Bait

Ready-to-use anticoagulant liquid baits are available in 'drinkers', particularly useful for Norway rat and house mouse control in dry conditions. For use in and around buildings in tamper-resistant bait stations.

The short guide to environmental assessments

Pre – Treatment

- Status of the site
- Adjacent features such as watercourse, woodlands, public footpaths
- Presence of mammal or bird predators/scavengers
- Access by domestic animals
- Species, degree and extent of infestation
- Any previous control carried out?
- Justification for the selection of the rodenticide to be used
- Materials and techniques to be used for protecting baits
- Potential for secondary poisoning to non-target species
- Facilities for safe disposal of rodent bodies and waste rodenticide

Treatment

Records should be kept to;

- Identify areas where bait has been laid
- Identify the active ingredient, formulation and quantities used
- Demonstrate the treatment frequency to check and replace baits and to search for and remove rodent bodies
- Report any effects on non-target species and action taken to reduce this
- Report any interference or removal of baits
- Report on conditions which may adversely affect treatment and remedial actions
- Demonstrate that control is being achieved

Post Treatment

On completion of the treatment, records should be updated to demonstrate that;

- The infestation has been controlled
- As far as is reasonably practicable all baits have been removed/bait stations emptied
- A final search has been made to locate and remove rodent bodies
- Any proofing or other environmental changes which may prevent re-infestation have been discussed with the client

Download the full environmental risk assesment from www.thinkwildlife.org

Rodent control methods - In line with Stewardship

For rodent control methods, please refer to **CRRU IRELAND CODE OF BEST PRACTICE: Best Practice and Guidance for Rodent Control and the Safe Use of Rodenticides.**

Undertaking rodent control in line with this best practice document is a requirement of the UK Rodenticide Stewardship Regime. This must be adhered to in order to reduce SGAR residues in birds of prey and other wildlife. A key principle of this guide is the 'risk hierarchy'. "The concept of 'risk hierarchy' should be at the forefront when deciding a

rodent control strategy for any site. The key here is that any intervention conducted must be potentially effective but, in the risk hierarchy, the least severe methods must always be used. It is not necessary that all options in the risk hierarchy should be employed, and found to fail, before an effective solution is reached. But all should be considered." The guide can be downloaded here <http://www.thinkwildlife.org/>

Killgerm® supports the campaign for responsible rodenticide use

- Always have a planned approach
- Always record quantity of bait used and where it is placed
- Always use enough baiting points
- Always collect and dispose of rodent bodies
- Never leave bait exposed to non-target animals and birds
- Never fail to inspect bait regularly
- Never leave bait down at the end of the treatment



ALPHACHLORALOSE

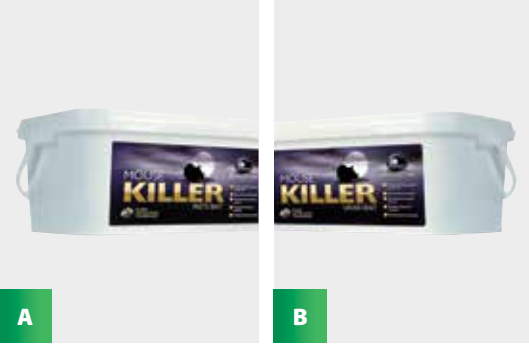

A

B

CHOLECALCIFEROL



C

COUMATETRALYL

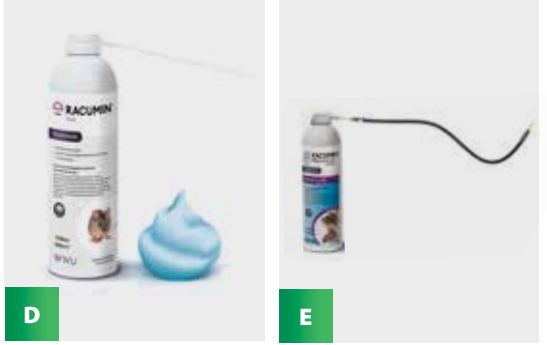

D

E

A BLACK PEARL PASTE BAIT | IE/BPA70057

PROFESSIONAL

Contains 4.00% alphachloralose.

A highly effective paste bait with patented active capsulation technology. Black Pearl immobilises mice almost instantly and has a narcotic effect, slowing down the metabolism of the rodent resulting in control by hypothermia. The new Active Capsulation Technology is a process by which the active ingredient molecule is surrounded or coated with a continuous film of polymeric material. The encapsulation of the Alphachloralose active ingredient ensures that a mouse cannot taste or sense it, and will very quickly consume the bait. The use of microencapsulation also ensures that the bait works quickly and effectively in all temperature extremes. Packed in 10g sachets.



BLKPEARLPASTE1K

1 x 1 kilo

B BLACK PEARL GRAIN BAIT

PROFESSIONAL

Contains 4.00% alphachloralose.

A highly effective pinhead oatmeal bait with patented active capsulation technology. Black Pearl immobilises mice almost instantly and has a narcotic effect, slowing down the metabolism of the rodent resulting in control by hypothermia. The new Active Capsulation Technology is a process by which the active ingredient molecule is surrounded or coated with a continuous film of polymeric material. The encapsulation of the Alphachloralose active ingredient ensures that a mouse cannot taste or sense it, and will very quickly consume the bait. The use of microencapsulation also ensures that the bait works quickly and effectively in all temperature extremes. Packed in 10g sachets.



BLKPEARLWHEAT1K

1 x 1 kilo

C SELONTRA® | BPR:UK-2020-1257

PROFESSIONAL

Contains 0.075% cholecalciferol

Selontra® is based on the non-anticoagulant rodenticide cholecalciferol, presented as a highly palatable soft block formulation. Cholecalciferol is effective against anticoagulant-resistant Norway rats and house mice. It is not bioaccumulative or persistent and therefore presents relatively lower secondary poisoning risks to non-target species, such as birds of prey, compared to second generation anticoagulants.



SELONTRA008K

1 x 8 kilos

D RACUMIN® FOAM | BPR:UK-2014-0860

PROFESSIONAL

Contains: 0.4% w/w coumatetralyl

Quick and easy to apply; ready to use product. Racumin® Foam takes advantage of a rat's grooming behaviour; rats groom 20% of the time in a 24 hour period, therefore contact with Racumin® Foam will ensure ingestion of the active ingredient. It can be placed in locations such as cavity walls, where traditional baiting methods are not possible.

It provides an additional level of control that cannot be achieved with current baiting techniques. Racumin® Foam offers an ideal solution where bait shyness or neophobia is an issue. Racumin® Foam is not a bait and therefore does not rely on palatability, once applied the disturbed foam provides a good visual guide to the level of rodent activity



RACFOAM500ML

1 x 500 ml

E FLEXIBLE AEROSOL STRAW KIT

Flexible extension straws for Racumin Foam and other aerosol sprays such as Bayer Crawling & Bayer Flying. The straws come supplied in a multi pack containing:

- 1 x 60cm flexible straw
- 1 x 30cm flexible straw
- 1 x cleaning tool
- 1 x actuator cap & connector (fits all common 4mm male aerosol valves)
- 1 x additional spare actuator cap

Made from robust chemical resistant tubing, the straws can be bent to the required shape and stay put.

AEROSTRAWKIT

Each

DIFENACOUM

BROMADIOLONE

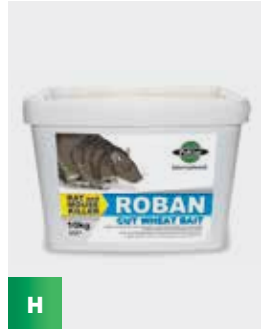
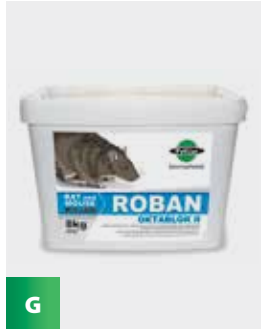

F SAKARAT® D WAX BAIT | BPR: UK-2012-0370 **PROFESSIONAL**

Contains 0.005% difenacoum

This highly effective second generation anticoagulant is a blend of cereal and palatable foodstuffs, which is ideal when competing with other foodstuff. Supplied in 300g plastic tubes for easy application (caulking gun) and transportation, which reduces contamination risks. Please note that on the summer formulation each tube is marked with a red batch number sticker. The winter formulation is marked with a blue sticker. Approved for rats and mice.



SAKDWAX300X10

10 x 300 g

G ROBAN OCTABLOK 8KG | IE70580 **PROFESSIONAL/TRAINED PROFESSIONAL USE**

Contains Difenacoum 0.005%

Our process of hot casting encases the blocks in wax giving considerably more protection from the elements when compared to extruded blocks.



ROBOCT08K

1 x 10 kilos

H ROBAN CUT WHEAT 10KG | IE70573 **PROFESSIONAL/TRAINED PROFESSIONAL USE**

Contains Difenacoum 0.005%

This cut wheat bait is formulated using top quality, dust-free chopped wheat with the active ingredient difenacoum and contains a highly appealing special aroma, giving the bait a unique chocolate smell.



PELROB10

1 x 10 kilos

I SAKARAT® BROMABAIT® | BPR: UK-2015-0931 **PROFESSIONAL**

Contains 0.005% bromadiolone

A whole wheat rodenticide containing bromadiolone, Sakarat Bromabait is ideal for use across the PCO sector. It is effective against rats and mice.



SAKBW010K

1 x 10 kilos

J CONTRAC ALL-WEATHER BLOX | BPR:UK-2015-0941 **PROFESSIONAL**

Contains 0.005% bromadiolone

A cereal based 28g block formulation with a low wax content and a special blend of food grade ingredients. The multi-edged design gives rodents plenty of gnawing surfaces. A hole in the centre makes it ideal for slipping onto security rods. Contains Bitrex™.



CONTRA008K

1 x 8 kilos

BRODIFACOUM

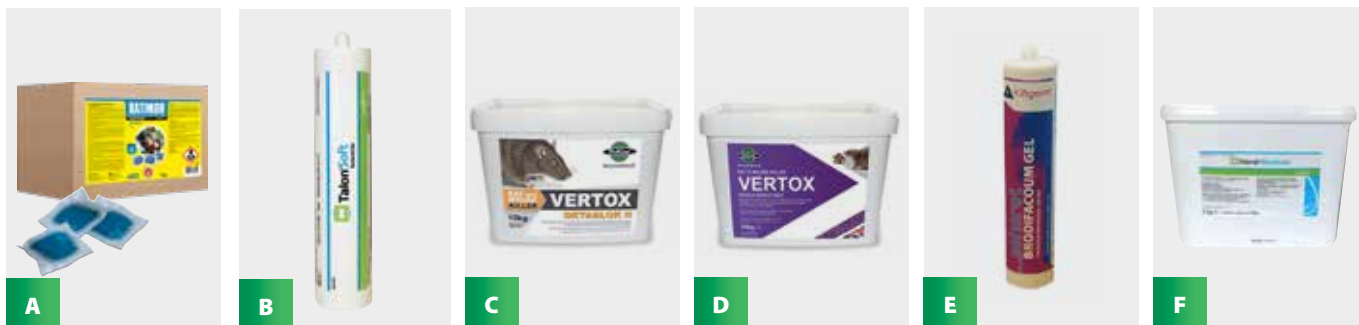
**A RATIMOR BRODIFACOUM FRESH BAIT | BPR: UK-2015-0857**

PROFESSIONAL

Contains 0.0029% brodifacoum

A highly efficient pasta bait with excellent palatability. Packed in individual 10g sachets.

**RATIBRODFRESH5K**

1 x 5 kilos

B TALON® SOFT | BPR: UK-2015-0910

PROFESSIONAL

Contains 0.005% brodifacoum

Talon® is a high-performance, single-feed rodenticide containing brodifacoum – a highly effective active ingredient against all rodents, even those which are resistant to other anticoagulants.

**TALONSOFT300X12**

12 x 300g

C VERTOX OCTABLOK 10KG | IE70534

PROFESSIONAL

Contains 0.005% Brodifacoum

The cast wax blocks are a highly palatable formulation suitable for use in all climatic conditions, especially areas of high humidity.

**PELVERTPBATCH**

1 x 10 kilos

D VERTOX WHOLE WHEAT 10KG | IE70538

PROFESSIONAL

Contains 0.005% brodifacoum

The whole wheat baits are formulated using food grade micronised (high temperature treated) wheat.

**VERTWW010K**

1 x 10 kilos

E SAKARAT BRODIFACOUM GEL | IE/BPA70830-002

PROFESSIONAL

Contains 0.005% brodifacoum

An innovative bait using Lipogel technology to create a highly palatable formulation. Blended using vegetable fats to get a soft, creamy and stable product.

**SAKBRODGEL10**

10 x 300g

F KLERAT WAXBLOCKS 10KG | IE/BPA 70601

PROFESSIONAL

Contains 0.0005% Brodifacoum

Klerat® Wax Blocks is a ready-to-use wax block bait, for use as a rodenticide by professionals, for the control of brown rats and mice indoors and outdoors around buildings for the protection of public health, animal health, stored products and materials.

**KLERBLOCK010K**

1 x 10 kilos

BRODIFACOUM

NON TOXIC INDICATORS



G

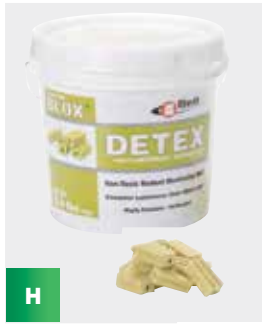

H



I

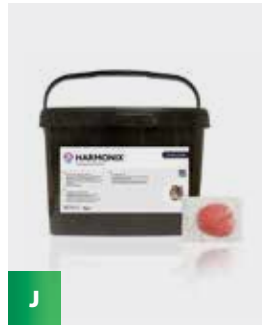

J

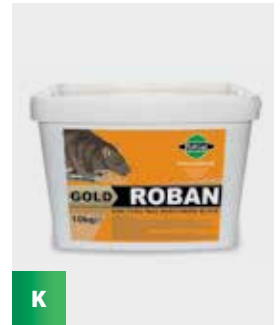

K

G SAKARAT BRODIKILL | BPR: UK-2017-1051

PROFESSIONAL

Contains 0.0029% brodifacoum

A whole wheat rodenticide containing brodifacoum, made from high quality micronized whole wheat. Single feed, for use against rats and mice. Can be used in and around buildings.



SAKBRODW010K

1 x 10 kilos

H DETEX BIOMARKER BLOX

A highly palatable, non-toxic, all weather monitoring bait. Used to indicate rodent activity prior to carrying out rodent treatments. Containing a special dye that is visible when exposed to UV light, helping to identify the home range and harbourage of rodents.



DETEX004K

1 x 4 kilos

I SAKARAT® MONITORING BAIT

Sakarati Monitoring Bait is a highly palatable toxic-free soft wax formulation, making it particularly useful in premises where toxic baits are only allowed for a riddance programme and not for monitoring. This excellent formula is for use as part of a professional rodent monitoring programme, where it is necessary to confirm rodent activity before carrying out a baiting programme.



WAXNONTOX

1 x 300 g

J HARMONIX® MONITORING PASTE

Harmonix Monitoring Paste is a new non-toxic monitoring bait and gives full traceability day and night. It is also free from the big 8 food allergens and is HACCP certified.

Key product facts:

- Non-toxic monitoring bait for use as part of an integrated approach
- Suitable for the food industry
- Free from the big 8 food allergens including wheat
- HACCP certified
- Day and night traceability



HARMON005K

1 x 5 kilos

K ROBAN GOLD 4KG

Non-toxic baits are becoming increasingly important in the battle against rodents where toxic baits cannot be used or should not be used permanently.



ROBNONTOXG

1 x 2.5 kilos

ROBNONTOXG

1 x 10 kilos

NON TOXIC INDICATORS



A



B

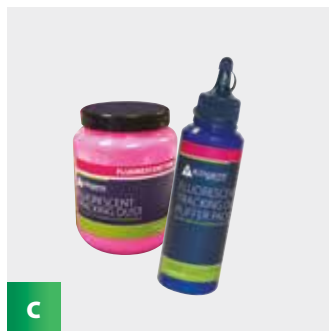

C



D

A UV TORCH

Compact, durable UV Torch for use with fluorescent baits. With 12 LED's. **Supplied with 3 AAA Batteries.**

	UVTORCHLED12	Each	
	BATTERYAAA	Pack of 10	

B FLUORESCENT TRACKING DUST (YELLOW)

A light non-toxic powder to aid the detection of rodent movements.



	FLURYEL100G	1 x 100 g puffer pack	
	FLURYEL250G	1 x 250 g	
	FLURYEL001K	1 x 1 kilos	

C FLUORESCENT TRACKING DUST (PINK)

A light non-toxic powder to aid the detection of rodent movements.



	FLURPINK100G	1 x 100 g puffer pack	
	FLURPINK250G	1 x 250 g	
	FLURPINK001K	1 x 1 kilos	

D SAKARAT® FLUORESCENT TRACKING GEL

Sakarats Fluorescent Tracking Gel is a professional use, non-toxic tracking gel for rats and mice. Can be used on horizontal or vertical surfaces, and allows tracks, routes, hideouts and harbourages to be easily identified. Can be used indoors or outdoors. Contains UV tracking technology and can be seen clearly.



	SAKTRACKGEL	1 x 300ml	
--	--------------------	-----------	--



You know when
you're in safe hands!

www.killgerm.com

sakarar[®]

RANGE

Manufactured by experts for use by professionals

Use biocides safely. Always read the label and product information before use.



AF® Snappa



Supplied in cases of:
 15 AF Snappa stations
 20 Inspection labels
 1 AF Plastic key

- A mouse bait station designed to trap mice using a Snap-E mouse trap so that the body of the mouse is not visible once trapped, discreet for food areas
- See-through lid available
- Fingers can't get inside the box - added safety
- A label can be affixed to the inside of lid - aiding record keeping
- Inspection slot enables you to see at a glance if the trap has been activated - ideal for inspections
- Fits onto the AF Shoe and AF Insect Monitor
- Takes the Snap-E mouse trap (not included) as well as bait blocks using bait block rods (optional extra)



VIDEO AVAILABLE ONLINE
www.killgerm.com

GOT A SMART PHONE
 Visit your app store to find a
 barcode reader for your device

AFSBLKBLK	Black lid/Black base	Box of 15	
AFSCLECLE	Clear lid/Clear base	Box of 15	
AFSRODS	Bait rods	Box of 15	
AFPLASTKEY	Plastic Key	Each	
AFKEY	Metal Key	Each	

Patented Technology

AF® Advance Mouse Box



A traditionally sized box with a host of features, many of which are exclusive to the AF Advance Mouse Box.

- User-friendly locking system
- Detachable lid for ease of servicing and record keeping
- Internal “fins” securely hold the most popular blocks on the market
- Feet on base will help to keep the Advance above water
- Fits onto the AF Insect Monitoring system to form an Integrated Monitoring/Control System
- Can be used with the AF Bait Box Security Shoe. The shoe allows the box to be secured to walls and floors.
- Has asymmetrical internal baffles – preventing access by human fingers
- Protected lock enhancing tamper resistance
- Optional extra liner available for loose grain bait and wax bait
- Optional bait rods to secure pasta baits
- Combined key/cleaning brush available as optional extra
- Corporate printing available

THE AF ADVANCE MOUSE BOX

ADV100BLA	Black	Box of 100	
ADV100WHI	White	Box of 100	
ADV100GRE	Green	Box of 100	
ADV100BLU	Blue	Box of 100	

AF® Mouse Box Accessories



A

A. AF® BAIT SHOE

This bait shoe is used to secure the AF Advance Mouse box, AF Discreet and AF Snappa.

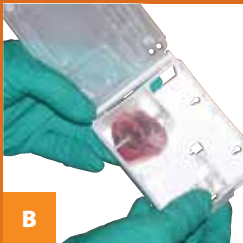

B

B. AF® ADVANCE MOUSE BAIT ROD

A bait rod to fit inside the AF Advance Mouse Box so that Pasta bait can be securely fixed.



C

C. AF® ADVANCE MOUSE BOX LINER

This small plastic liner fits exclusively into the AF Advance Mouse Box and accommodates loose grain bait and wax bait. The AF Advance Liner makes cleaning easier.



D

D. AF® MOUSE BOX – CABLE FIXING

Both the AF Advance and AF Discreet can be held in place using 1.2mm birdwire (NET149) and you will need crimps (NET073) and crimping pliers (BIR018). Leave enough wire to allow the box to be lifted and serviced during inspection, usually 40-50cm.



E

E. THE AF® BRUSH KEY

A handy brush in food grade blue nylon with the AF Key attached/installed to the end. This convenient brush is ideal for cleaning loose debris and dust from bait boxes and allows more purchase when opening boxes in the cold!

AFMSHOE	ADVRODS	ADVLINER	NET149	100 metres	AFRBRUSH
Box of 50	Box of 50	Pack of 250	NET073	Pack of 100	Each
			BIR018	Each	

MOUSE BAIT STATIONS



A



B



C



D



E

A AF® ADVANCE MOUSE BOX

Larger and more enticing to mice, the 'AF Advance' is modelled on its predecessor the 'AF Discreet'. The first mouse box that can secure pasta bait on an optional bait rod. Supplied with 100 date/inspection labels and 1 plastic key. **Personalisation available, initial screen costs €46.00. Printing cost: 200-400 stations = 10 pence per station. 500+ stations = 6 pence per station**

ADV100BLA	Box of 100	Black	
ADV100WHI	Box of 100	White	
ADV100GRE	Box of 100	Green	
ADV100BLU	Box of 100	Blue	
ADVLINER	Pack of 250 liners		
AFMSHOE	Box of 50 AF Shoe		
AFPLASTKEY	Plastic key		
AFMLABELS	Pack of 50 labels		
AFBRUSH	Brush/key		
ADVRODS	Pack of 50 bait rods		

B AF® SNAPPA®

A compact trap mouse bait box that allows a mouse trap to be used inside the box. Bait rods are available as an optional extra. Supplied with inspection labels and an AF plastic Key.

AFSBLKBLK	Box of 15	Black lid/Black base	
AFSCLECLE	Box of 15	Clear lid/Clear base	
AFSRODS	Box of 15	Bait rods	

C NO. 7 - MOUSE BAIT STATION

A tamper-resistant plastic mouse bait station, ideal for use with wax blocks. **Personalisation available on minimum order quantity of 5 x 100 (screen €40.00).**

7UK100B	Box of 100	Black	
---------	------------	-------	--

D PULSE MOUSE IQ STATION

Bell sensing technology. Te Bell IQ range comes with a fully intergrated battery, proprietary sensor and antenna, that is water ans weatherproof.

PULSEMSEIQ6	Pack of 6		
-------------	-----------	--	--

E NO. 4 - CARDBOARD BAIT BOXES

A cost effective and convenient way to present a wide variety of rodenticide formulations. Ideal for use in secure areas where Tamper Resistant Boxes are not required. Internally waxed to be resistant from moisture and absorption from contained bait. Available in multilingual version.

4UK100BOX	Pack of 100		
-----------	-------------	--	--

MOUSE TRAPS



E



F



G



H

E SNAP-E MOUSE TRAP

Advanced mouse trap using hygienic and durable materials. The bait is placed in a cup in the middle of a pressure-sensitive plate, which releases a strike bar that has only half the distance to travel of conventional traps, providing a fast, clean kill every time. The trap is set from behind so that fingers do not come below the strike bar.

SNAPEMSE Each

F TRAPPER MINI REX

A quick set trap that can be used with one hand. It has a removable bait cup to increase safety and ease of servicing. The open end should be placed towards the wall where the mice run, so that they enter from front or sides.

TRAPMINREX Each

G HIDDEN KILL MOUSE TRAP

The Hidden Kill Mouse Trap is an economical choice for pest controllers looking for a discreet option for trapping mice. The trap is designed with a quick, no mess capture and kill mechanism that is an upgrade from the unsightly kill of outdated wooden traps. With a stealthy, low-profile design it blends into a variety of surroundings. Built with a fully enclosed capture area, it keeps the captured mouse hidden inside. The Hidden Kill is a premium quality trap that is built to withstand a variety of environments.

- Easy, no touch disposal
- Two-way entry allows mice to enter from either direction
- Innovative design for optional corner placement
- Removable bait cup for safe and easy baiting

HIDDENKILLMSE Each

H CLIP BOX MOUSE TRAP

The Clip Box Mouse Trap is an easy to set reusable mouse trap made from durable ABS Plastic. The trap has a two-way entry allowing mice to enter from either direction. Simply slide the setting switch backwards to set and then place the trap in areas of activity.

CLIPMOUSETRAP Each

MOUSE TRAPS

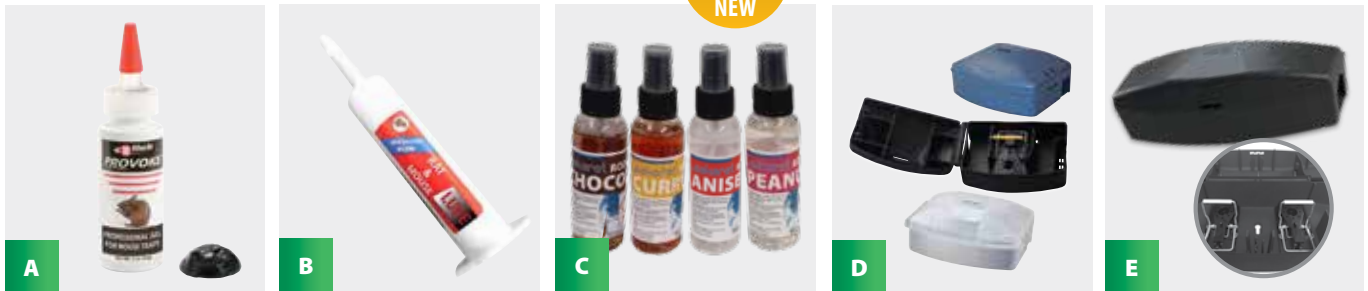

A PROVOKE GEL FOR MOUSE TRAPS

Even the most finicky mouse will have a hard time resisting Bell's mouse trap gel, Provoke Professional Gel for Mouse Traps. Developed by the same experts that formulate Bell's highly effective baits, Provoke is a mouse trap gel specifically developed for mice. Non-toxic and hypoallergenic, Provoke is especially useful in accounts where food products to draw rodents to the trap, such as peanut butter, are prohibited. Provoke can easily be dispensed on any type of mouse trap using the conveniently-sized 2 oz./56g squeeze bottle with nozzle. This water soluble gel won't stain carpets or clothing.

PROVOKE2OZ 1 x 2oz (56g) Bottle

B BACON RAT AND MOUSE LURE

Bacon Rat and Mouse Lure is a blend of food-grade material and oil designed specifically for trap shy rats and mice. The long lasting formula is non-toxic and has no known allergens. For use with any device such glueboards, live traps and snap traps.

BACONLURE30ML 1 x 30ml

C SAKARAT RODENT LURE

Sakarot Rodent Lure - use as a bait on its own or as a fragrance to disguise the odour of new boxes and human interaction. When applying the spray, both rats and mice are less cautious to approach boxes. Available in 100ml bottles, in 4 flavours:

- Aniseed
- Peanut
- Chocolate
- Curry

SAKANISEED100ML Aniseed

SAKPEANUT100ML Peanut

SAKCHOC100ML Chocolate

SAKCURRY100ML Curry

D AF® SNAPPA®

A compact trap mouse bait box that allows a mouse trap to be used inside the box. 15 bait bars are available (optional extra) so that bait blocks can be used. Supplied with inspection labels and an AF plastic key. **SNAP-E TRAPS SUPPLIED SEPARATELY**

AFSBLKBLK Box of 15 Black lid/Black base

AFSCLECLE Box of 15 Clear lid/Clear base

AFSRODS Box of 15 Bait Rods

E AF® TUNNEL

The AF Tunnel has been updated, whilst still retaining it's compact and robust qualities. The updated design features a new key and locking mechanism. The new design allows two mouse traps to be fitted, without obstructing the run through. **SNAP-E TRAPS SUPPLIED SEPARATELY**

Personalisation available, initial plate costs €50.00.

Printing cost: 10 x 12 (120 stations) = 20 pence per station.

Printing cost: 25 x 12 (300 stations) = 15 pence per station.

AFTUNNEL Box of 12

RAT BAIT STATION



A

S/C Steel rat bait stations

A versatile steel bait box suitable for outdoor use

It accommodates most bait formulas, i.e. blocks, loose grain with tray and snap traps

Top steel locking mechanism with a steel key supplied with boxes



A	S/C STEEL RAT BAIT STATIONS
MET01	
MET02	



AF[®] Amicus



Scan the QR code to see the AF[®] Amicus video.

Wildlife Conscious Rat Control

RODENT CONTROL



- Species-specific bait station
- Reduces risk of non-target species entrance
- Allows rodenticides to be used, with lower risk, in all suitable areas
- Reduces risk when using traps
- Stops slug and snail damage to rodenticides
- Reducing risks to wildlife should be considered as part of an Environmental Risk Assessment



The unique downward facing tubes naturally attract rats and allow them to climb up into the box, giving access to the rodenticides or traps inside.

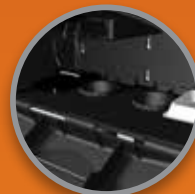

AF[®] Amicus accommodates many bait formulations and can also be used with break-back rat traps if required.



Readily accessible by the technician and with a removable door that also acts as a useful shelf, AF[®] Amicus will hold many of the usual types of rodenticides and traps.

The new wildlife conscious rat box from Killgerm[®]

THE AF[®] AMICUS

AFAMICUS

Pack of 4



AF® Fortis



Scan the QR code to see the AF® Fortis video.

Thinking 'inside' the box!



SNAP TRAP



SAKARAT D LIQUID BAIT



BLOCK BAIT AND PASTA SACHETS



FRESH BAIT TRAYS OR GRAIN BAIT

Versatility is the key

The robust metal key for the AF® Fortis is supplied separately.



A strong and intelligent metal bait box with the same outstanding quality of the AF® range.

- High quality steel bait station.
- Robust one-piece removable plastic liner accommodates all bait formulations - pasta, loose grain, blocks, liquid bait, as well as snap traps including Snap-e and Trapper T-Rex.
- Four metal rods supplied with each box can be used in both horizontal and vertical positions.
- Top key entry with hinged lid provides quick and easy servicing.
- Available in black or green and powder coated in a very high-quality, matt finish.
- Raised entrance holes and ramps on the robust one-piece liner help to keep the box weatherproof.
- Corporate printing available.
- Compatible with the AF® Ground Anchor for use on soft ground.

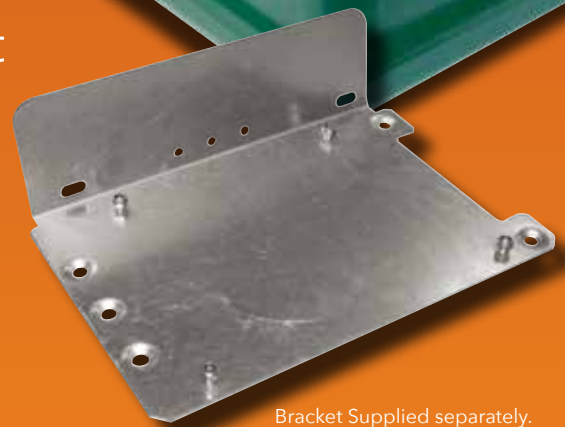

Bracket Supplied separately.

THE AF® FORTIS

AFFORTISBLK	Black Station	Each	
AFFORTISGRE	Green Station	Each	
AFFORTISKEY	Key	Each	
AFFORTISBRACK	Bracket	Each	



AF[®] Rat Box

THE MOST VERSATILE RAT BOX ON THE MARKET, THE AF[®] RAT BOX HAS MANY UNIQUE FEATURES.

- Detachable lid for ease of servicing and record keeping
- Removable lid makes cleaning easier
- Unique locks for added security
- Front facing locks reduce the risk of blockage from debris
- Several securing options available aiding due diligence
- All common formulations can be used allowing a wide choice of rodenticides
- Can be used with break-back traps.
- Protected lock enhancing tamper resistance
- Tripod foot configuration aids stability
- Drainage barriers in the entrance of the tunnel together with additional drainage holes mean that the box is now even more water resistant
- Ribs have been extended down from the lid to interface with the internal walls. This enhances tamper resistance and adds to the box's strength
- Enlarged rod support lugs on the inside of the lid to provide a more positive capture area for vertical rods
- Horizontal metal bait rod will hold the most popular bait blocks securely in place
- Dimensions H: 105mm x W: 355mm x D: 255mm
- Corporate printing available



THE AF[®] RAT BOX

AFRATBOX	Box of 6	
AFRLINER	Pack of 24	

AF[®] Atom

ALL GOOD THINGS COME IN SMALL PACKAGES

This small and compact, stackable bait box offers a high quality, affordable alternative to larger bait boxes

- Versatile – can use a break back trap or block baits either vertically or horizontally
- Stackable design for ease of storage and transportation
- Tamper resistant box
- Single AF lock – accessible from the front to stop debris build up in the lock
- Sloping entrance tunnel to help prevent water ingress
- Detachable lid for ease of inspection & record keeping
- Combined key/cleaning brush available as optional extra
- **Dimensions: W: 265 mm x H: 100 mm x D: 190 mm**

€4.75

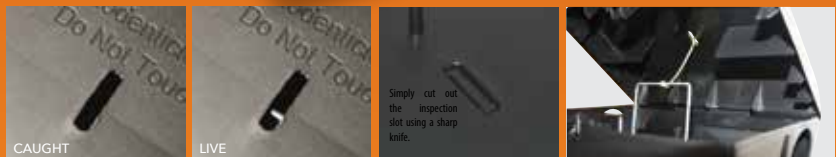

THE AF[®] ATOM

AFATOMBLK	Box of 8	
AFALINER	Pack of 40 liners	
CABLEVEL98MM	Pack of 100 (98mm x 2.5mm)	

AF RAT / ATOM BOX ACCESSORIES

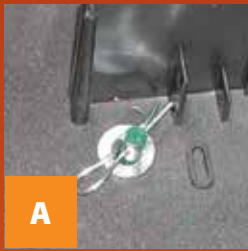

A. AF® RAT BOX – BAIT STATION ANCHOR

Ideal for fixing the rat box into soft ground, it can be hammered into position using one of the pre-drilled holes in the base.

STATANCH	Each	
-----------------	------	--



B. BAIT BOX PAD

The bait station self adhesive pad is a quick and easy solution for the anchorage of bait boxes at a fixed location both indoors and outdoors. The self adhesive pad will also stick to porous surfaces such as bricks. Just peel off the paper protecting the sticky surface, place the pad at the desired location and press firmly for 10-20 seconds. Using the recommended cable fixing (1.2 mm bird wire and crimps), attach the bait station to the pad.

BAITBOXPAD	Pack of 100	
-------------------	-------------	--



C. AF® RAT BOX – CABLE FIXING

When fixing brackets are not appropriate, this quick and easy fixing method is ideal. Attach one end of 1.2mm stainless steel wire rope (NET149) to the bait box as indicated and attach the other end to a wall, fence etc. (you will need crimps (NET073) and crimping pliers (BIR018) for this fixing method. See bird section of this catalogue). Leave enough wire to allow the box to be lifted and serviced during inspection, usually 40-50cm.

NET149	1.2mm Wire rope	100 metres
NET073	1.5mm Copper ferrules	Pack of 100
BIR018	Crimping pliers	Each



D. THE AF® BRUSH KEY

A handy brush in food grade blue nylon with the AF Key attached/installed to the end. This convenient brush is ideal for cleaning loose debris and dust from bait boxes and allows more purchase when opening rat boxes in the cold!

AFRBRUSH	Each	
-----------------	------	--



E SNAP-E RAT TRAP/TRAPPER T-REX

Can be used in the AF Rat Box for a quick kill of a single rat.

SNAPERAT	Each	
TRAPPTREX	Each	



AF[®] Tunnel



NEW
DESIGN

SMALL, LOW-PROFILE AND DISCREET

- Small, low-profile and discreet.
- A compact and robust rat bait tunnel with the same outstanding quality of the AF[®] range.
- New design key locking system for increased security.
- This versatile tunnel can be used with blocks, grain, pasta, pasta trays and can hold two Snap-E Mouse Traps.
- The new bait bar is attached inside the lid, favouring the natural feeding behaviour of rodents.
- The lid can be removed completely for better access.
- Locator key hole in base.
- Corporate printing available.
- Dimensions: W: 130 mm x H: 111 mm x D: 320 mm.

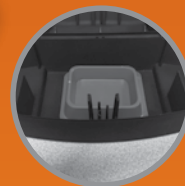

BOX OF 12

THE AF[®] TUNNEL

AFTUNNEL	Box of 12	
AFTUNNKEY	Each	

AF[®] Underground



The AF Underground bait box brings together all the superb features associated with the AF Range but offers you versatility, security and discretion that no other bait box offers. The AF Underground enables the most natural environment for feeding, as the box should be buried in the ground and the inside can be lined with soil, creating a natural flooring. Up to four access points offer additional entrance and escape routes for nervous rodents.

- Discreet box – designed to be buried, whilst the lid has the appearance of a drain cover
- Secure Tamper Resistant Box
- Strong and resilient against environmental pressures
- Versatile – the length of the entrance tunnel can be

- adjusted to suit your needs
- All baits can be used with retaining bars supplied to secure block baits
- Box can be secured using ground anchors or can be cemented in place where the installation is intended to be permanent
- Designed to sit on gravel with holes in the base to assist drainage and therefore assist in keeping bait fresh
- Spring loaded lid to aid servicing
- 1 metre of pipe supplied with box. Additional pipe can be purchased
- Discreet and secure for public areas ie. grass and shrubbery areas around shopping centres



Possible locations for the AF Underground Rat Box



Dimensions: 36cm x 36cm x 13.5cm

AFUNDBOX	Each	
AFUNDHOSE	Per metre length of hose	
AFUNDDRIVE	T-30 Driver Tool	



VIDEO AVAILABLE ONLINE
www.killgerm.com
 GOT A SMART PHONE
 Visit your app store to find a barcode reader for your device

AF[®] Tyre-Baiter



IDEAL FOR USE ON FARMS AND LANDFILL SITES

- Encourages communal feeding
- Increases uptake of bait by providing a natural feeding area
- Protects bait from larger non-target animals
- Environmentally responsible design - Reusing old tyres
- Maximum diameter of tyre: 640mm (tyre not supplied)

PLEASE NOTE THAT BAIT RODS ARE SOLD SEPARATELY



TYREBAITER	Each	
TYREBAITROD	Each (Stainless Steel) bait rod	

RAT BAIT STATIONS



A AF® RAT BOX

The most versatile rat box on the market, this addition to the AF Range has many unique features and benefits. These include a detachable lid for ease of servicing and record keeping, ability to use all common formulations of rodent bait, and drainage barriers and drainage holes even more water resistant.

Personalisation available, initial plate costs €52.00.

Printing cost: 6 x 6 (36 stations) = €0.25 cents per station.

Printing cost: 36 x 6 (216 stations) = €0.22 cents per station.

AFRATBOX	Box of 6	
AFRLINER	Pack of 24 liners	

B AF® ATOM

A small and compact bait box that offers a high quality, affordable alternative to larger bait boxes. An optional inspection slot features in the lid of the AF Atom. This enables pest controllers to see at a glance if the trap has been triggered making inspections quicker and easier. The slot can be easily cut out of the lid following the impressed moulding with a sharp knife. Additional brightly coloured cables ties can be purchased which makes identification of triggered traps easier to detect from a distance.

Personalisation available, initial plate costs €52.00.

Printing cost: 6 x 8 (48 stations) = 20 pence per station.

Printing cost: 25 x 8 (200 stations) = 15 pence per station.

AFATOMBLK	Box of 8	
AFALINER	Pack of 40 liners	

C AF® TUNNEL

A compact and robust bait tunnel with the same outstanding quality of the AF Range. Can hold 2 snap-e mouse traps, and can be used with blocks, grain, pasta sachets and pasta trays.

Personalisation available, initial plate costs €52.00.

Printing cost: 10 x 12 (120 stations) = 20 pence per station.

Printing cost: 25 x 12 (300 stations) = 15 pence per station.

AFTUNNEL	Box of 12	
-----------------	-----------	--

D AF® FORTIS

A high quality steel bait station, featuring a removable plastic liner that accommodates all bait formulations - pasta, loose grain, blocks, liquid bait, and snap traps. Four metal rods supplied with each box can be used in both horizontal and vertical positions. Top key entry with hinged lid provides quick and easy servicing. **An outer contains 6 stations.**

Personalisation available, initial plate costs €52.00.

Minimum quantity for personalisation is 24 stations.

AFFORTISBLK	Black Station	Each	
AFFORTISGRE	Green Station	Each	
AFFORTISKEY	Key	Each	
AFFORTISBRACK	Bracket	Each	

E AF® MULTIS TRAPPING STATION

The AF Multis is a multi-purpose trapping station that can be used with a wide range of traps, including: Goodnature A24, Goodnature A18, Fenn MK4, Magnum 110/116, and a range of snap traps. It can also be used with a range of rodenticide formulations.

Personalisation available, initial plate costs €52.00.

Printing cost: 8 x 4 (32 stations) = 20 pence per station.

AFMULTIS	Box of 4	
-----------------	----------	--

RAT BAIT STATIONS



F AF® UNDERGROUND BAIT STATION

A discreet, underground bait station that is tamper resistant and is made from Zintec coated steel. Designed to be buried, with the lid having the appearance of a drain cover. Extra lengths of the entrance hose are available. **Key/tool sold separately.**

AFUNDBOX	Each	
AFUNDHOSE	Per metre length of hose	
AFUNDDRIVE	T-30 Driver Tool	

G PULSE RAT IQ STATION

Bell sensing technology. The Bell IQ range comes with a fully intergrated battery, proprietary sensor and antenna, that is water and weatherproof.

PULSERATIQ6	Box of 6	
--------------------	----------	--

H PROTECTA EVO EDGE

PROTECTA EVO Edge is a versatile rodent bait station that is easy to use and service. The station opens and locks quickly with Bell's EVO key. The built-in service record card holder, side-opening design and rounded interior walls make servicing fast, maximising technician productivity. The station has a large bait capacity holding up to eight 28g Blox securely inside the station and comes with vertical securing rods. Designed for more than just bait, PROTECTA EVO Edge also accommodates two TRAPPER Mini T-Rex mouse snap traps, or a TRAPPER T-Rex rat snap trap, which can be set forward in the runway. Technicians can swiftly adjust baiting or trapping tactics, without having to switch out their equipment. Made from 100% recycled, heavy duty injection-molded plastic. Rear mounting holes allow station to be secured to a fence.

PROTEVOEDGE	Box of 6	
--------------------	----------	--

I PROTECT® LANDSCAPE RAT BAIT STATION

A side-opening rodent bait station that blends into the surrounding landscape, ideal for when discretion is key. 4 vertical bait securing rods hold 8 - 28g Blox or 4 - 225g Blox. The single lock opens with the EVO Bell key. Accommodates snap traps and is available in 2 different colours.

PROTLANGR	Box of 4	Granite	
PROTLANSA	Box of 4	Sandstone	

J PROTECTA® EVO AMBUSH RAT BAIT STATION

Made from heavy duty injection-moulded plastic, this low-line station can be used with both baits and a Trapper T-Rex trap. A new unique key and locking system allows for quick servicing and the removable tray enables easy cleaning.

PROTAMBUSH	Box of 6	
-------------------	----------	--

K PROTECTA EVO TUNNEL

An economical and versatile way to protect traps at accounts. Can be used indoors or outdoors, and can be secured to fences or pipes via cable ties in both the vertical and horizontal position. Provides tamper-resistant coverage of a variety of rat and mouse traps. The Evo Tunnel can also provide cover for mouse sized products such as two Mini-Rex mouse snap traps, two Trapper® Mouse glue trays or two Trapper® Max glue boards. Opens and locks quickly with Bell's Evo key.

PROTECTUNNEL	Box of 6	
---------------------	----------	--

BAIT TRAYS & FIXINGS



A



B



C

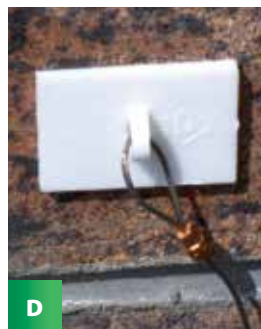

D

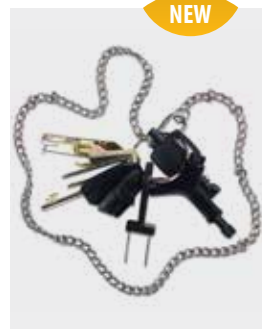

NEW

A NO.2 - SMALL OBLONG (85MM X 65MM X 21MM DEEP) RED

These useful trays made from recycled High Impact Polystyrene (HIPS) can be used to present a wide range of rodenticides including grain, seeds, rolled oats, and pellets.

TRAYNO2S0 Pack of 100

B NO.3 - LARGE OBLONG (145MM X 94MM X 30MM DEEP) WHITE

Our innovative new bait tray has an improved stable design which reduces the risk of being tipped over and feed being wasted. The robust and durable tray is made from polypropylene which is easy to clean and likely to be more acceptable to a feeding rodent.

TRAYNO3LO Pack of 100

C BAIT STATION ANCHOR

For securing tamper resistant bait stations to soft ground. Ingenious split pin allows removal of station for cleaning, only when station is opened with key.

STATANCH Each

D BAIT BOX PAD

The bait station self adhesive pad is a quick and easy solution for the anchorage of bait boxes at a fixed location both indoors and outdoors. The self adhesive pad will also stick to porous surfaces such as bricks. Just peel off the paper protecting the sticky surface, place the pad at the desired location and press firmly for 10-20 seconds. Using the recommended cable fixing (1.2 mm bird wire and crimps), attach the bait station to the pad.

BAITBOXPAD Pack of 100

I BAIT BOX KEY SET

A set of keys for use with the most popular bait stations, including:

- AF Range
- AF Fortis
- No7 Mouse Box
- Protecta Evo Key
- Protecta LP Key

Also included is an 85cm stainless steel chain.

KEYBOXSET Each

NEW



AF[®] Multis

Trapping Station

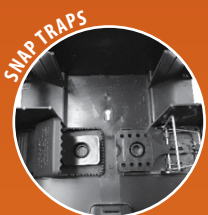
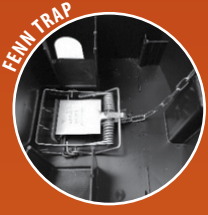
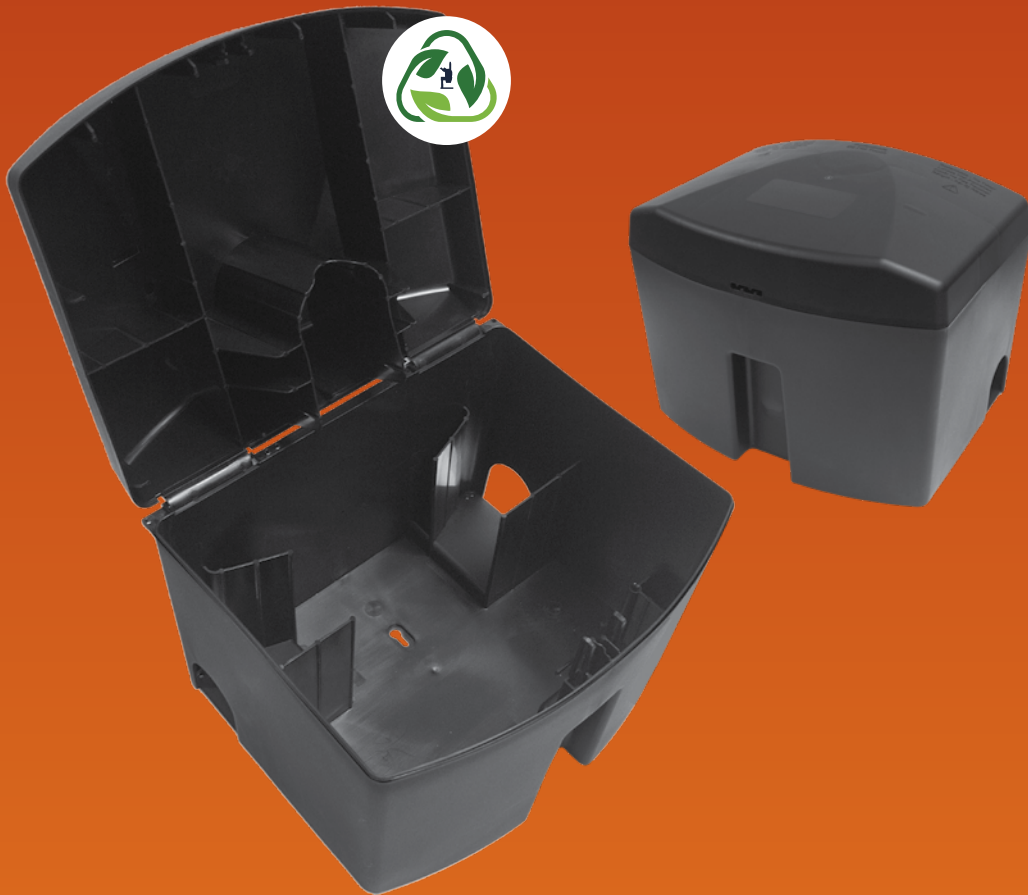

The AF[®] Multis is a multi-purpose trapping station that can be used with a wide range of traps, including: Goodnature[®] A24, Goodnature[®] A18, Fenn MK4, Magnum 110/116, and a range of snap traps.

It can also be used with a range of rodenticide formulations including blocks, loose grain, pasta sachets and fresh bait trays. The detachable lid allows for ease of servicing and three optional inspection slots allow the pest controllers to see at a glance if traps have been triggered. The new style AF key and lock allow for quick but secure access. The station can be secured using the bait station anchor, locator key hole in base or tethered using cable fixings.

THE AF[®] MULTIS

AFMULTIS

Pack of 4

RAT TRAPS

**A BIG SNAP-E RAT TRAP**

The larger version of the Snap-E specially adapted for rats with a much stronger spring and holes in the base plate for securing. Big Snap-e rat traps are made of durable ABS plastic and steel. They resist stains and odours common in old fashioned wooden traps, are easy to clean, and can be reused for years of service.

SNAPERAT Each

B TRAPPER T-REX

The trap is a perfect combination of trigger sensitivity and trap velocity. Safer and easier to use, the Trapper T-Rex can be readily set by foot safely on the ground. Press the trap open like a pedal, keeping fingers free and safe. The Trapper T-Rex includes a removable bait cup which greatly enhances safety. You can use Trapper T-Rex along a rat pathway or you can insert it into a tamper-resistant bait station.

TRAPPTREX Each

C T-REX RAT IQ

Bell sensing technology. The Bell IQ range comes with a fully intergrated battery, proprietary sensor and antenna, that is water ans weatherproof.

TREXIQTRAP Each

D DOC 150

Approved for use against rats, weasels, stoats and grey squirrels.

DOC150TRAP Each

E DOC 200

Approved for use against rats, weasels, stoats, grey squirrels and mink.

DOC200TRAP Each

F DOC TUNNEL

Specifically designed to be interchangeable with the DOC 150 and 200 Traps. This closed end tunnel has clear baffles, therefore making it easy to check for any catches, an easy set plate for setting the traps, and also lure station. They're lightweight, strong, UV stabilised, durable and recyclable.

DOCTRAPTUNNEL Each

RAT TRAPS

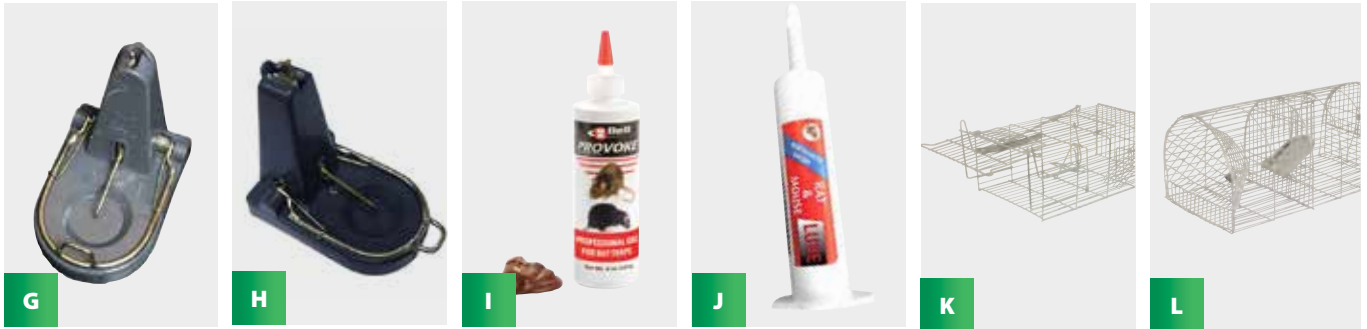
**G BLACK CAT RAT TRAP**

The Black Cat Rat Trap is an easy to set, powerful break back trap. The trap is made from plastic and has a galvanised steel killing bar. Bait must be placed under the trigger hook before setting. We recommend that this trap is used in the AF Multis Trapping Station to reduce the risk of catching non target species.

BLACKCATTRAP Each

H NANO BLACK CAT RAT TRAP

The Nano Black Cat is an easy to set, powerful break back trap. Made from plastic with a galvanised steel killing bar. We recommend that the trap is used in the AF Multis Trapping Station or the AF Amicus to reduce the risk of catching non target species. Its smaller size will also allow its use in safe restricted areas. For example, to the rear of kick-boards on kitchen units. Bait must be placed under the trigger hook before setting.

BLACKCATNANO Each

I PROVOKE GEL FOR RAT TRAPS

Provoke Professional Gel for rat traps is a food-based gel that has been specifically designed to meet the unique behavioural characteristics of rats. Since rats are driven more by scent than taste, Provoke for rats contains a unique blend of scents that Norway and roof rats find enticing. Provoke can be dispensed easily onto any rat trap via its convenient 8 oz./224g squeeze bottle. Like its mouse counterpart, Provoke Professional Gel for rat traps is hypoallergenic; it can be used in sensitive areas where food products to draw rodents to the trap, such as peanut butter, are prohibited. It is also water soluble so it won't stain carpets or clothing.

PROVOKE80Z 1 x 8oz (228g) bottle

J BACON RAT AND MOUSE LURE

Bacon Rat and Mouse Lure is a blend of food-grade material and oil designed specifically for trap shy rats and mice. The long lasting formula is non-toxic and has no known allergens. For use with any device such glueboards, live traps and snap traps.

BACONLURE30ML 1 x 30ml

K KC73 RAT TRAP

A neat single catch trap for removal of rats in domestic, commercial and agricultural application. Constructed from 12swg welded mesh. Zinc-plated finish. Weight 0.8 kilos.

KC73TRAPS 355mm x 203mm x 178mm

L KC74 MULTI-CATCH RAT TRAP

A tried and tested traditional design. 1/2 round with flat bottom and funnel entrance. Constructed from 15swg welded mesh. Zinc-plated finish. Weight 1.0 kilos.

KC74TRAPS 406mm x 203mm x 178mm

Goodnature A24 Rat & Stoat Trap



- The Goodnature A24 Trap is a CO₂ powered, multiple kill device, suited to a number of environments including roof spaces, woodlands, industrial sites and farms.
- The trap is easy to install, maintain and will automatically reset 24 times per CO₂ canister.
- Each kit is supplied completed with a long-life lure, 2x CO₂ canisters, 3 rodent detector cards and instructions for use.
- The Goodnature A24 Trap is fitted with an automatic counter. The counter is used to notify how many rodents have been caught in the event of them being moved after being killed.
- Now available is the AF Multis Trapping Station, that allows the Goodnature A24 Trap to be housed inside.
- Cleared for use against mice and weasels.

GOODA24COUNTERKIT Each

REPLACEMENT CO₂ CARTRIDGES

GOODNATCART10 Pack of 10



SAFETY TUNNEL

GOODA24TUNNEL Each



REPLACEMENT ATTRACTANT/LURE (CHOCOLATE)

GOODNATLURE Each



LURE POUCH (CHOCOLATE)

GOODPOU200CHOC Each



STAND

GOODNATSTAND Each



AF® MULTIS TRAPPING STATION

AFMULTIS Pack of 4





RatMat



VIDEO AVAILABLE ONLINE
www.killgerm.com
 GOT A SMART PHONE
 Visit your app store to find a
 barcode reader for your device

RatMat is an innovative, humane and cost effective solution to protect property from rodents.

Using the principles of an electric fence, the RatMat tiles can be used as a long term solution to prevent rats and mice causing expensive damage to property such as motor vehicles. The RatMat is safe, scalable and transportable and doubles as a hardwearing floor surface.

The main safety feature of the RatMat is the low energy pulse it uses. This is dramatically less powerful than a standard electric fence.

Each RatMat tile measures:
 310mm x 310mm x 12mm.

RATMAT TILES

RATMAT TILE10 Pack of 10



RATMAT EDGES

RATMAT EDGE25 Pack of 25



RATMAT CORNERS

RATMAT CORN10 Pack of 10



RATMAT ENERGISER (AND CONNECTIONS)

RATMAT ENERUK Each



A4 WARNING SIGN

RATMAT A4WARN Each





Digital Pest Management™

RODENTS

The Digital Pest Management System is a wireless network of high-tech trap sensors that provide 24/7 monitoring, real-time capture alerts and up-to-the minute rodent activity verification.

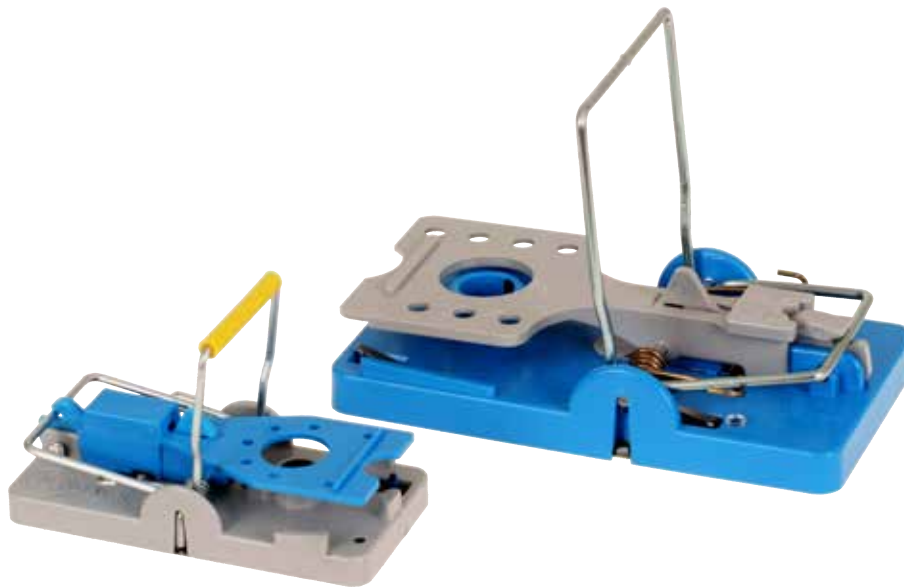

Available to purchase are both mouse and rat traps. These are linked to the system via a gateway, which is provided as part of a yearly subscription.

Please contact your local Area Sales Manager or Customer Service Team for further information and pricing.



Help optimise integrated pest management (IPM) efforts and creating full visibility of service delivery.



Helps improve pest inspections & audit readiness.



Helps prevent infestations.

Prevent

Manually checking each trap can divert focus from the true purpose of Integrated Pest Management programs. Whether you rely on a third party pest management service or manage an in-house program, the Bayer rodent monitoring system can provide the time needed to think outside the trap and proactively manage the risks associated with rodents.

Correct

With 24/7 monitoring, real-time capture alerts and up-to-the minute program verification, you have the data to take immediate corrective action, preventing further infestation.

Predict

Bayer provides valuable data, allowing you to protect your brand, your reputation and your site by analyzing patterns to find root causes and predict future rodent problems. Improve accountability with concise records to deliver compliance..



IoT technology provides 24/7 monitoring and real-time capture alerts so you can respond proactively instead of relying on manual trap checking.

- Instant response to the presence of rodents in your facility with real-time automated alerts sent to your smartphone or tablet
- Ensure the correct personnel receive alerts with role-based notifications
- Monitor rodent activity in real-time across multiple facilities so you can take fast action
- Ensure network performance with automated system status reports
- Daily data capture enables detailed analytics and heat mapping capability

Robust reporting features help ensure you have the evidence you need to prove compliance with ever-tightening regulations

- Be prepared for audits with up-to-the minute rodent program verification data
- Perform fast root-cause analysis with time-stamped data
- Achieve transparency related to your pest control efforts across facilities with collaborative tools
- Improve pest control process for protecting your brand, reputation, clients, employees and facility by analysing system data
- Develop clear trend analysis data to efficiently deliver pest management systems



Work smarter and spend your time on proactive measures utilising expertise to prevent infestations

- Help protect public health and prevent risk of product recall with intelligent, optimise food safety and cleaning practices
- Dedicate labor resource to preventative, proactive measures to ensure conditions are not hospitable to rodents
- Place monitors strategically thanks to graphic floor plan visualisations and pest activity heat maps

LABELS / SIGNS



A

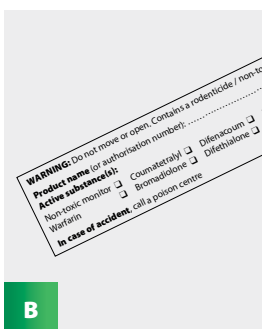

B



C



D



E

A RODENTICIDE WARNING SIGN

This reusable rodenticide warning sign ensures that the pest control technician complies with current legislation when using rodenticides in public areas/open areas. The Rodenticide Warning Sign has space to write the details of the pest control provider, baiting period, areas baited, contact numbers and the rodenticide used. The sign also includes a warning notice of the risk of both primary and secondary poisoning by anticoagulants, as well as the first aid measures to be taken in the event of an accident. The sign is made from 2mm PVC Foamex measuring 210 x 148mm. Each pack contains 25 pre drilled signs that are quick and easy to attach to posts, fences or trees in a variety of outdoor baiting situations.

WARNSIGN25

Pack of 25

B BAIT STATION WARNING STICKER

Rodenticide labels now refer to a requirement for labelling bait stations with certain information. To make life simpler for pest controllers, Killgerm have produced a new 'Bait Station Warning Sticker'. This sticker contains the required information and can be affixed to the outside of mouse and rat bait stations. The sticker is waterproof, resistant to UV-light and can be written on with permanent marker pens or ballpoint pens. Measures 90mm x 25mm.

BAITSTATWARN

Pack of 100

C WALL PLAQUES

Wall plaque signs measuring 80mm x 110mm, printed black on 1mm thick hi-impact styrene.

WALLPLAQUE

Pack of 25

D DANGER POISON WARNING LABEL

A yellow and black label with a high tack adhesive and excellent UV and water resistant features, measuring 11cm x 7.8cm. For use in buildings, on vehicles or wherever a poisonous substance is present.

LABELDP1

Pack of 50

E POISON RODENT BAIT DO NOT HANDLE LABEL

A red and white label with high tack adhesive, measuring 7.6cm x 3.6cm. Can be used as an additional high impact warning label on bait stations.

LABELP1

Pack of 100

LABELS / SIGNS

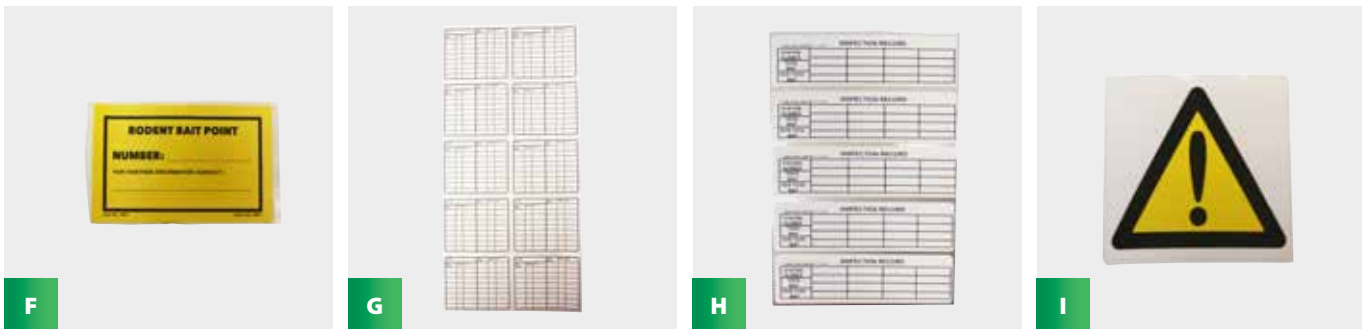

F

G

H

I

F RODENT BAIT POINT NUMBER LABEL

A yellow and black label with high tack adhesive and excellent UV and water resistant features, measuring 11.6cm x 8cm. Perfect for identifying baiting / monitoring points when carrying out pest control inspections.

LABELRBP1

Pack of 100

G AF BAIT STATION INSPECTION RECORD LABEL

A black and white label with high tack adhesive, measuring 6cm x 5cm. A perfect solution for recording pest control inspections when using the range of AF boxes.

AFMLABELS

Pack of 50

H BAIT STATION INSPECTION RECORD LABEL

A black and white label with high tack adhesive, measuring 10cm x 3cm. A perfect solution for recording pest control inspections in tamper resistant bait stations.

LABELN07

Pack of 100

I HAZARD WARNING LABEL

A yellow and black label with high tack adhesive and excellent UV and water resistant features, measuring 10cm x 10cm. Perfect for alerting staff, visitors and emergency response teams to a potential safety hazard. For use in buildings and on vehicles.

LABELEXCL

Each

ANCILLARY PRODUCTS

ODOUR CONTROL PRODUCTS



A SCOOT FOX REPELLENT AMATEUR NC

Contains 88% aluminium ammonium sulphate

Widely acclaimed as the most effective fox repellent on the market Scoot is a patented non toxic formula used to keep foxes away from protected areas. It works by mimicking scent marking odours thus leading any foxes that may be present to vacate the area in the belief that another animal has taken over its territory. Scoot is totally safe for use in gardens, on plants and edible crops and is humane, bio-degradable and very effective. 100g makes upto 18 litres with a coverage of approximately 70m².

SCOOT100G	1 x 100g	
------------------	----------	--

B RODENT BAIT BAGS

A clear plastic bag to hold bait securely. Each bag is printed with a warning that rodent bait is held inside. Size = 6 inch x 8 inch. Made from biodegradable plastic.

RODENTBAG	Pack of 1000 bait bags	
RODBAGSEAL	Bait bag sealer	
RODBAGTAPE	Bait bag tape	

C RODENT DEODORANT

HAZARD INFORMATION: H226, H317, H414, P210, P233, P242, P261, P272, P273, P280, P302 + P352, P333 + P313, P362, P391, P403, P501

To mask smells arising from inaccessible rodent bodies.

RODDE001L	1 x 1 litre		
------------------	-------------	--	--

D ODOUR REMOVER BAG

A non-toxic and biodegradable way to remove unwanted smells and odours. Earth Care Odour Remover simply and easily removes the odours caused by dead rats, mice as well as many other odours, including cats and dogs. Place the odour remover bag as close to the source of the smell as possible and it will literally soak up the unwanted smells.

Dimensions: 260mm x 140mm.

ODOURBAG	Each	
-----------------	------	--

E DEADLINE ODOURISING SACHETS

A convenient pack of specially formulated material to render stale and unpleasant odour inoffensive.

ORCHISACH	Pack of 10	
------------------	------------	--

PROOFING

BRISTLE STRIP

Keep out insects, birds and rodents with the Killgerm bristle strip. Correctly fitted to seal gaps around doors and windows, Killgerm bristle strip will help prevent vermin from gaining access to buildings. As an added bonus, it also helps to seal against draught, dust and noise pollution.

Supplied in 1.0 metre lengths and six trim sizes from 20mm to 150mm, the Killgerm bristle strip gives you the opportunity to offer extra service to your customers by not just eliminating vermin from their premises, but also preventing re-infestation. All Killgerm sections are available with flat (180), 45 or 90 degree angled fixing carrier, suitable for a variety of fixing situations.



A

FLAT FLANGE

REFERENCE	A	B	C	D	LENGTH	PRICE
(BRISTLE LENGTH)						
2/20-180-1.0	11.0mm	7.0mm	6.7mm	20mm	1.0 metre	
2/34-180-1.0	11.0mm	7.0mm	6.7mm	34mm	1.0 metre	
3/44-180-1.0	13.0mm	8.4mm	8.0mm	44mm	1.0 metre	
4/80-180-1.0	18.0mm	11.0mm	10.5mm	80mm	1.0 metre	
4/102-180-1.0	18.0mm	11.0mm	10.5mm	102mm	1.0 metre	



B

90° ANGLED FLANGE

REFERENCE	A	B	C	D	LENGTH	PRICE
(BRISTLE LENGTH)						
2/20-90-1.0	17.5mm	6.7mm	6.7mm	20mm	1.0 metre	
2/34-90-1.0	17.5mm	6.7mm	6.7mm	34mm	1.0 metre	
3/44-90-1.0	22.6mm	8.5mm	8.0mm	44mm	1.0 metre	
4/80-90-1.0	28.0mm	10.8mm	10.8mm	80mm	1.0 metre	
4/102-90-1.0	28.0mm	10.8mm	10.8mm	102mm	1.0 metre	



C

BOTTOM DOOR SEAL

Ready-to-fit Bottom Door Seal.
Housed in pre-slotted extruded aluminium fixing carrier
Available in 914mm (36") lengths

DOORSEAL26MM	26mm Bristle	
DOORSEAL44MM	44mm Bristle	

PROOFING

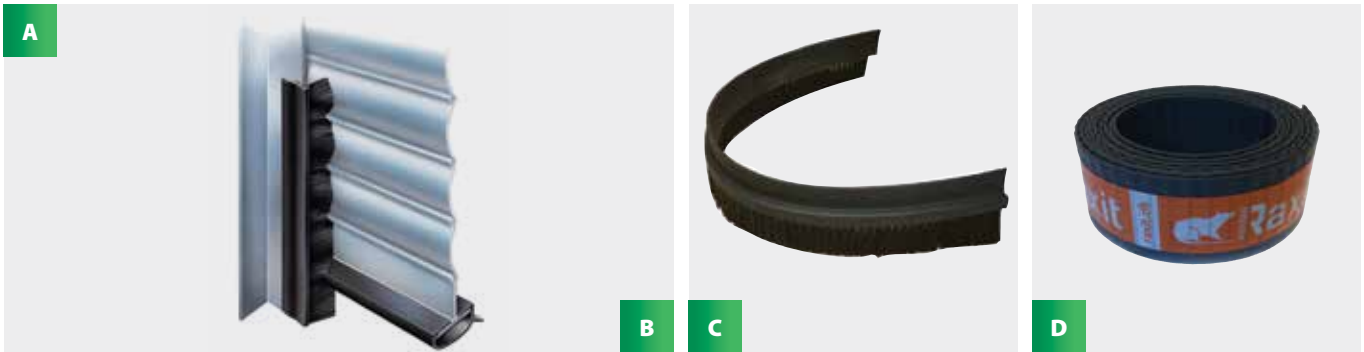
**A ROLLERSEAL**

A clip on UPVC carrier with brush insert for proofing the vertical guide rails of roller shutter doors, typically used on warehouses, industrial units, etc. Together with the Bumperseal, the Rollerseal provides a complete proofing system for roller shutter doors.

ROLLA1.5M	1.5m length
------------------	-------------

B BUMPERSEAL

A rubber seal that clips straight onto the bottom bar of a roller shutter door, providing an effective seal even onto uneven floors. The Bumper Seal is hollow and designed to squash down, and used for gaps of no more than 15mm. The Bumperseal can be fitted in minutes without any need for tools or additional fixings. Together with the Rollerseal, the Bumperseal provides a complete proofing system for roller shutter doors.

BUMPER5M	5 metres
-----------------	----------

C FLEXIBLE BRISTLE STRIPS

- Fitted correctly seals gaps around doors and windows. The flexible bristle strip can impede rodents, birds and insects from entering
- The strip can also prevent draught, dust and noise pollution
- Supplied in 25m rolls with differing trim lengths and easily cut using a sharp knife or hacksaw
- The bristle strip can be secured using screws, glue or profile adhesive wrapping tape

FLEXIBRUSH20MM	20mm Bristle
-----------------------	--------------

FLEXIBRUSH40MM	40mm Bristle
-----------------------	--------------

D RAXIT DOORSEAL ROLL

The Raxit Door Seal is a convenient 3-meter length proofing seal that can be easily cut to size. It can be used to proof doors, gates and gaps on buildings. The seal when fitted enables you to securely proof the threshold against rodents and other pests. Made from 3.2mm wide flame retardant Santoprene™ this highly flexible and durable material is reinforced with steel wires to stop rodents from chewing through. The seal is corrugated to ensure the steel wires inlaid into the seal do not slide. The seal can be fixed using flat headed screws and an adhesive sealant such as Avisil/Avifix. If required a protection strip can be fitted (Wood, Aluminium, Plastic or Stainless steel) to maintain the look of the proofed area. Width of roll 75mm.

RAXIT3MROLL	3 metres
--------------------	----------

PROOFING

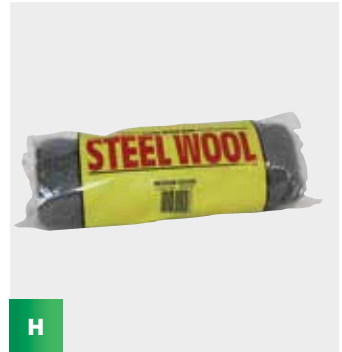
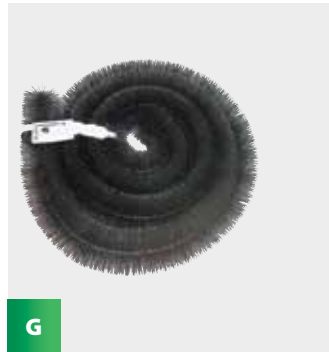

E XCLUDER MESH

XCLUDER is designed to stop gnawing and burrowing pests from entering your home, office or building in a safe and environmentally responsible way. Made from stainless steel and poly fibers, XCLUDER has more “spring-back” than other pest exclusion products. The extra spring-back allows XCLUDER to fill crevices and remain in place indefinitely ensuring rodents cannot get past it or remove it.

Superior to Wire Wool in the following ways:

- Far less material used per gap or hole
- Avoids rust and decomposition
- Avoids any marking or leakages
- Xcluder does not decompose due to its composition of stainless and UV resistant poly fibers
- Xcluder’s spring back behaviour / flexibility keeps the material firmly in the gap.
- Fast and highly effective installation due its composition and shape

XCLUDER10FT	10 foot long x 4 inches wide	
--------------------	------------------------------	--

F FLEXIBLE PROOFING MESH

Flexible Proofing Mesh is available in both 50mm x 20 metre and 150mm x 10 metre rolls. This proofing mesh is made from stainless steel links making it weather resistant while remaining flexible enough to fold, roll and cut to size. It is a cost-effective way of proofing a wide range of rodent and bird access points and creates a pest proof barrier while still allowing ventilation to buildings.

FLEXIMESH50MM	50mm x 20metres	
FLEXIMESH150MM	150mm x 10metres	

G RODENT BRUSH

The Rodent Brush is easily installed and removed for a wide range of proofing needs and made from high quality UV resistant polypropylene with a high grade stainless steel inner core. The brush can be placed into conduits, enclosures, open pipes, pathway drainage gullies, guttering and preformed construction panels which restricts access to water sources. Supplied in 4m lengths with a diameter of 100mm which can be easily cut using wire cutters.

RODBRUSH4M	4m x 100mm roll	
-------------------	-----------------	--

H WIRE WOOL

450g bag of medium-grade steel wool to be used for restricting access to rodents around small holes and gaps.

WIREWOOL	1 x 450g	Each	
-----------------	----------	------	--

PROOFING

**A MOUSEMESH VENT IN WHITE**

Mousemesh prevents mice from entering a property via existing in-built air brick vents. This unique pest control innovation is one of the few truly preventative measures currently available.

- Easy to fit
- Hard and highly durable plastic frame
- Stainless steel insert ensures its durability in all weathers
- Can be fixed using screws or strong adhesive

VENTSMALL	245mm x 95mm (9" x 4")	
VENTMEDIUM	245mm x 170mm (9" x 7")	
VENTLARGE	245mm x 245mm (9" x 9")	

B MOUSEMESH VENT IN BROWN

Mousemesh prevents mice from entering a property via existing in-built air brick vents. This unique pest control innovation is one of the few truly preventative measures currently available.

- Easy to fit
- Hard and highly durable plastic frame
- Stainless steel insert ensures its durability in all weathers
- Can be fixed using screws or strong adhesive

VENTBROWNSM	245mm x 95mm (9" x 4")	
VENTBROWNME	245mm x 170mm (9" x 7")	
VENTBROWNLA	245mm x 245mm (9" x 9")	

C MOUSEMESH VENT IN BLACK

Mousemesh prevents mice from entering a property via existing in-built air brick vents. This unique pest control innovation is one of the few truly preventative measures currently available.

- Easy to fit
- Hard and highly durable plastic frame
- Stainless steel insert ensures its durability in all weathers
- Can be fixed using screws or strong adhesive

VENTBLACKSM	245mm x 95mm (9" x 4")	
VENTBLACKME	245mm x 170mm (9" x 7")	
VENTBLACKLA	245mm x 245mm (9" x 9")	

D MOUSEMESH VENT IN STAINLESS STEEL

Mousemesh prevents mice from entering a property via existing in-built air brick vents. This unique pest control innovation is one of the few truly preventative measures currently available.

- Easy to fit
- Stainless steel frame
- Stainless steel insert ensures its durability in all weathers
- Can be fixed using screws or strong adhesive

VENTSTSTSM	245mm x 95mm (9" x 4")	
VENTSTSTME	245mm x 170mm (9" x 7")	
VENTSTSTLA	245mm x 245mm (9" x 9")	

PROOFING



E



F



G

E ALUMINIUM MOUSE PROOFING GRILLES

A range of solid plate proofing plates designed to prevent rodent incursion through airbricks and similar access points. Produced in Aluminium to prevent weathering, these plates provide long lasting, tough and discreet protection. Extremely useful in industrial premises as when fixed to walls they offer a low profile solution.

GRILL245X95	245mm x 95mm (9" x 4")	
GRILL245X170	245mm x 170mm (9" x 7")	
GRILL245X245	245mm x 245mm (9" x 9")	

F WEEP HOLE FITTINGS

Weep Hole Fittings provide a solution to avoid rodents and wasps entering cavity walls through drainage and ventilation holes.

- Provide outstanding flexibility.
- Quick and easy to fit.
- No tools necessary.
- Made from strong stainless spring steel.
- Fit into 6cm high holes neatly, securely, and discreetly.
- Can also be cut to fit into smaller holes.

CAVITY6CM	Pack of 20	
------------------	------------	--

G AF® RODENT PROOFING CONE

The AF Rodent Proofing Cone is a quick and simple solution to help prevent rodents from gaining access to properties.

- The cone can be used on both round and square pipes of various sizes from 50mm to 110mm.
- It is easily attached to the pipe using cable ties and the cone can be cut to size to create a rodent proof barrier.
- The kit comprises of 10 cones, cable ties and fitting instructions.

AFRODCONE10	Pack of 10	
--------------------	------------	--

PROOFING



A MOUSESTOP

Mousestop is a non-toxic ready to use paste which helps prevent rodents gaining access and to protect buildings. Mousestop is water repellent and can be painted.

MOUSE300ML	1 x 300ml	Each
-------------------	-----------	------

B SAKARAT® RODENT STOP

Sakarot Rodentstop is a non-hazard classified ready-to-use paste, which helps prevent rodents gaining access to sensitive areas and to protect buildings. Ingredients: Made out of natural ingredient and PS pearls.

SAKRODBARRIER	1 x 300ml	Each
----------------------	-----------	------

B SAKARAT® RODENT BARRIER (METAL DETECTABLE)

Incorporating stainless steel fibre technology in a silicone body, Sakarat Rodent Barrier is easy to apply using a conventional caulking gun. Use for sealing gaps, holes, cracks and crevices to prevent ingress by rodents. Safe to use in food environments and effective within 20 minutes. Fully waterproof with an 8-10 year life expectancy.

SAKRODSTOP	1 x 300ml	Each
-------------------	-----------	------

C EXPANDING FOAM GUN GRADE

A one component, ready to use polyurethane PU foam. Very good adhesion on most substrates and excellent mounting capabilities. Applied using a professional applicator gun with a special gun and foam cleaner available for cleaning applicator guns, valves of the PU foam aerosol and removal of un-cured foam.

FOAMGUN	Applicator Gun	Each
FOAMGUN750ML	Gun Grade Aerosol 750ml	Each
FOAMCLEAN	Cleaner Aerosol	Each

Goodnature A18 Squirrel Trap



GOODA18SQUIRREL Each

REPLACEMENT CO₂ CARTRIDGES

GOODNATCART10 Pack of 10

LURE POUCH (HAZELNUT)

GOODPOU200HAZE Each

STAND

GOODNATSTAND Each

METAL COVER

GOODA18COVER Each



- The Goodnature A18 Squirrel Trap is a CO₂ powered, multiple kill device, suited to a number of environments including roof spaces, woodlands, industrial sites and farms.
- The trap is easy to install, maintain and will automatically reset 18 times per CO₂ canister.
- Each kit is supplied with a tree mount, 200g lure pouch, lure basket, 2 x CO₂ Cylinders, counter and success guide.
- The included automatic counter notifies how many squirrels have been caught in the event of them being moved after being killed.
- A sturdy but lightweight powder coated aluminium cover is available, that can be used to effectively conceal traps when used in open areas. The cover gives the trap added protection from squirrels that may try to chew through the lure basket or other exposed areas of the trap. When fitted, the cover still allows full access for squirrels to enter the trap.



The Goodnature A18 Squirrel Trap can also be used in conjunction with the KC84 Tunnel.

This then allows the trap to be used with the KC86 Trap Mounting Bracket & KC87 Trap Locating Paddle.

KC84 TUNNEL

KC84TUNNEL Each

KC86 TRAP MOUNTING BRACKET

KC86BRACKET Each

KC87 TRAP LOCATING PADDLE

KC87PADDLE Each

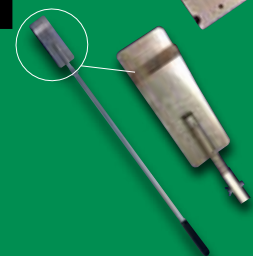

VIDEO AVAILABLE ONLINE
www.killgerm.com

GOT A SMART PHONE
Visit your app store to find a barcode reader for your device

SQUIRREL CONTROL

RABBIT CONTROL

CAT CONTROL

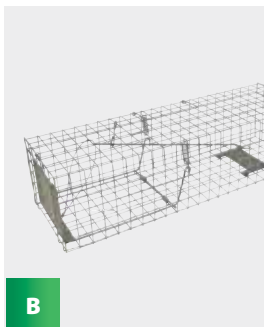
**A FENN TRAP (MK4)**

A traditional sprung trap with treadle trigger mechanism for the control of grey squirrels and rats. Care should be taken to avoid trapping non-target species by placing in covered runs or burrows or by using a suitable artificial tunnel.

FENNTRAP4

Each

B KC71 SQUIRREL / MINK TRAP

A single catch trap for removal of a variety of animals, including squirrels or mink. A unique door-pull wire aids trap setting and removal of the specimen. Constructed from 25mm x 25mm (1" x 1") 12swg welded mesh. Zinc-plated finish. Weight 1.3 kilos.

KC71TRAPS

584mm x 178mm x 153mm

C KC75 RABBIT TRAP

A single catch, heavy welded mesh trap to MAFF specifications. The cage is made from a single piece of mesh and welded closed with no sharp points or additional clips. Constructed from 25mm (1") square 12swg welded mesh with Zinc-plated finish. Weight 3 kilos.

KC75TRAPS

737mm x 254mm x 254mm

D FENN TRAP (MK6)

A larger version of the MK 4 trap for use in controlling rabbits, grey squirrels, weasels, rats and mink. The same precautions with regard to non-target species should be observed.



VIDEO AVAILABLE ONLINE
www.killgerm.com

GOT A SMART PHONE
 Visit your app store to find a
 barcode reader for your device

FENNTRAP6

Each

E KC76 CAT TRAP

A single catch, heavy welded mesh trap with a two-spring trip plate for efficient capture. Unique door-pull wire allows easy setting and aids in the humane removal of the animal from the trap. Constructed from 25mm x 25mm (1" x 1") 12swg welded mesh. Zinc-plated finish. Weight 3 kilos.

KC76TRAPS

736mm x 280mm x 254mm

CAT CONTROL

DOG/FOX CONTROL



F



G

F CAT GRABBER

A simple and effective means for capturing and controlling cats. It is widely used in rescue situations where the cat is in a confined space or out of normal reach. It is particularly useful for dealing with feral cats where it eliminates any need for manual contact with the animal and the risk of physical injury to personnel.

180 - 305

Cat grabber 76cm

G KC80 FOX / DOG TRAP

Heavy welded mesh trap with bait hook and sliding trip door. Efficient closing mechanism ensures the animal remains within the trap. Constructed from 25mm x 25mm (1" x 1") 12swg welded mesh. Zinc-plated finish. Weight 12.4 kilos.

KC80TRAPS

1220mm x 460mm x 460mm

Stainless Steel Ratflap



The Ratflap provides a permanent, simple solution to the problem of rats in sewers. The device prevents rats from moving from the main sewer into the pipes servicing properties.

The Ratflap is now even easier to install. It can be placed in either the upstream or downstream location inside the sewer. Simply insert in the chosen pipe, making sure that the arrow on the unit points in the same direction as the flow of waste.

The product is made from acid resistant stainless steel and exerts enough force on the inside of the pipe to stay secure but for added security a stainless steel wire lanyard is also supplied.

DRAINRATSS4	Flap to fit 4" drains	
DRAINRATSS6	Flap to fit 6" drains	

DRAINAGE EQUIPMENT

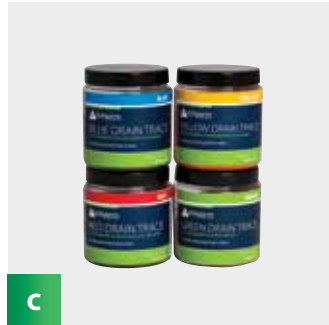

A UNIKEY - MANHOLE COVER LIFTING KIT

The Killgerm Unikey is a universal manhole cover lifting key kit. It comes supplied with a range of interchangeable tips which can easily be attached to the two handles allowing most manhole covers to be lifted. Made from Zinc plated carbon steel the handles and tips have a safe working load of 250kg (1000Kg straight pull destructive testing). The kit includes:

- Two heavy duty handles. A range of interchangeable tips including:
- 2 x 33mm T-Tips | 2 x 22mm T-Tips | 2 x 10mm Side Entry Hooks | 2 x M10mm Threaded Screw Tips
- 2 x M12mm Threaded Screw Tips | 2 x M16mm Screw Adaptors | 1 x Long Stopcock Tip

UNIKEYKIT	Each	
------------------	------	--

B MANHOLE COVER LIFTING KEY

A specially designed universal drain key for opening and lifting drain covers. The key is long at 82cm and enables the user to lift covers without bending. Two lifting keys required per manhole cover.

DRAINKEYL	Each	
------------------	------	--

C DRAIN TRACING DYES

For testing and tracing leaks in drains. Available in 200g Jars.

TRACEJARG	Fluorescent Green	
TRACEJARR	Red	
TRACEJARB	Blue	
TRACEJARY	Yellow	

D DRAIN TRACING SACHETS

For testing and tracing leaks in drains.

TRACESACG	Box of 10	Fluorescent Green	
------------------	-----------	-------------------	--



小島 **BIRD FREE**



Protecting the urban environment

BIRD CONTROL



- Ready to use dishes
- Quick, easy, mess-free installation
- Making working at heights safer and easier
- Firm texture enables use on pitched roofs and angled surfaces
- Discreet low profile dishes
- Keeps pigeons away from structures without harming them
- Authorisation number: UK-2018-1127

BIRD FREE DISHES

BIRDFREE15

Box of 15 dishes

BIRD FREE MAGNETIC DISHES

BIRDFREEMAG15

Box of 15 dishes



Application of 小島 **BIRD FREE** at Case study 1

Pigeons had been nesting on the window ledges of this converted church for many years. Three years ago the nests were removed and 小島 BIRD FREE was applied. The pigeons have not returned.



Application of 小島 **BIRD FREE** at Case study 2

Pigeons were roosting on the frame of the station roof and fouling the platforms below. Since 小島 BIRD FREE was applied to the roof in 2014 pigeons no longer roost there.

BIRD FREE® STIQ

Installing Bird Free is now even easier thanks to the Stiq. It is designed to lock Bird Free dishes into place, allowing for quicker lid removal. The Stiq is the go-to tool to use on any jobs involving Bird Free. Modern bird control is even more in your hands with the Stiq. A hole on the handle allows it to loop onto anything. The 6" handle length shows the minimum recommended distance between Bird Free dishes. Contains helpful instructions on the handle showing how to install Bird Free.

BIRDFREESTIQ	Each	
--------------	------	--

ADHESIVES

Silirub 2	SILIRUB2300ML	300ml cartridge	
Fixall High Tack	FIXHITACK290ML	290ml cartridge	
Fixall Crystal	FIXCRYSTAL300ML	300ml cartridge	

AS A GUIDE, ONE TUBE OF ADHESIVE WILL GLUE 90 DISHES

BIRD FREE CABLE TIE PADS

BIRDFREEHOL15	Pack of 15 pads	
---------------	-----------------	--

CABLE TIES

CABLETIE430MM	Pack of 100	
---------------	-------------	--

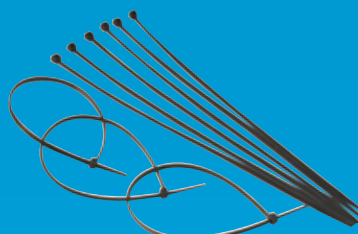

Bird management



In the pages of this catalogue you will find the tools and fittings required to apply all of the best known and most effective urban bird control techniques available. A wide selection of fittings are listed and illustrated to help you choose the best system for your bird problem.

Systems and some products are graded to illustrate the level of effectiveness they will provide to withstand the “pressure” of the birds trying to regain access to the proofed areas. This “pressure” grading needs to be understood to be able to choose the right system for the job.

The grading system is explained fully in the catalogue, together with brief system overviews and fitting instructions.

This catalogue is not intended to be a training document and persons without the necessary experience and skill are strongly recommended to attend one of the urban bird control training courses run by Killgerm. Mistakes can be very expensive.

Killgerm also has a highly trained and experienced technical team that can offer specialist advice over the phone.

If there is something you need that is not in the catalogue, please contact us. We may be able to get it for you or suggest an alternative.

NEW

WE NOW HAVE OUR OWN BRAND **NEW EXCLUSIVE RANGE** OF PRODUCTS FOR BIRD CONTROL FROM KILLGERM.

QUICK GUIDE TO BIRD PROOFING SYSTEMS

		PIGEONS							
		DEFENDER NARROW STST	DEFENDER WIDE STST	DEFENDER EXTRA WIDE STST	BIRD NET	BIRD WIRE	DADDY LONG LEGS	CHIMNEY GUARD	BIRD FREE
INFESTATION	Heavy (Nesting/Night Roosting)			✓	✓			✓	
	Medium (Daytime perches)		✓	✓	✓	✓	✓	✓	✓
	Light (Occasional Landing)	✓	✓	✓	✓	✓	✓	✓	✓
SURFACE	Ledges, Parapets, Beams etc	✓	✓	✓	✓	✓			✓
	Signs, Pipes, Rails	✓	✓	✓		✓			✓
	Windows Reveals/ Window Sills		✓		✓	✓			✓
	Gutters		✓			✓			✓
	Roofs				✓		✓		
	Chimney Pots							✓	
	Chimney Stacks	✓	✓	✓	✓				✓
	Canopies	✓	✓	✓	✓				✓
	Street Lamps	✓	✓	✓			✓		✓
	Air Conditioning Units	✓	✓	✓	✓		✓		✓
	Silo Tops						✓		✓

		GULLS					
		DEFENDER GULL STST	CHIMNEY SPIKE	BIRD NET	BIRD WIRE	DADDY LONG LEGS	CHIMNEY GUARD
INFESTATION	Heavy (Nesting/Night Roosting)			✓			✓
	Medium (Daytime perches)	✓	✓	✓	✓	✓	✓
	Light (Occasional Landing)	✓	✓	✓	✓	✓	✓
SURFACE	Ledges, Parapets, Beams etc	✓		✓	✓		
	Signs, Pipes, Rails	✓			✓		
	Windows Reveals/ Window Sills	✓		✓	✓		
	Gutters	✓					✓
	Roofs		✓	✓		✓	
	Chimney Pots		✓				✓
	Chimney Stacks	✓	✓	✓			
	Canopies	✓		✓			
	Street Lamps	✓					✓
	Air Conditioning Units	✓				✓	✓
	Silo Tops					✓	✓

Choosing the correct system

Mistakes in the choice of bird proofing systems can lead to embarrassing and expensive failures. Each system is only effective against certain species of bird. Different systems have different abilities to withstand the “pressure” that the birds will exert in trying to get back onto the proofed areas.

Below is a brief description of the three main classifications:

HEAVY PRESSURE

Parts of a building used for nesting and night roosting. Generally a lot of fouling with nests, eggs and squabs. Birds are highly motivated to regain access. Netting is the only system that is likely to be successful in this situation. Spike systems designed for heavy pressure situations will give limited success but will most likely need to be backed up by a selective cull. Bird Free may also be considered for ledges where nesting occurs.



MEDIUM PRESSURE

Regular day roost, usually overlooking a food source. Often heavily fouled. Netting and spikes can be confidently considered here. Follow the recommendations against the products in the catalogue. Bird Free may also be considered for ledges where nesting occurs.



LIGHT PRESSURE

Occasional daytime roost usually on an exposed part of the building. Little fouling to be seen. Any ledge products such as Birdwire, Daddi Long Legs, Spikes or Birdfree maybe considered.



Against each entry in the catalogue is the species of bird to which the product is effective. There is also an indication of the amount of pressure that each system is designed to withstand. Several different systems may be required on a building to effectively keep birds off.

Remember. System failure is expensive in time, labour, materials and reputation.

Beware of displacement. Moving birds to an adjoining building is fine (they may be your next customer!) but moving them to part of the same building is not.

To achieve the best results remember the following:

- carry out a thorough survey
- use quality materials
- ensure you are properly trained in the various installation techniques

Both products and training are available from Killgerm.



BIRD NETTING

HEAVY PRESSURE

Bird netting systems can be used against any of the urban pest species. When fitted properly, with the correct mesh size for the species of bird, a net will keep even the most persistent of birds out of the heaviest bird pressure sites.

Nets can be fitted horizontally to exclude pest birds from open areas such as wells and courtyards. They can also be fitted vertically to proof large frontages of buildings. As a combination of horizontal and vertical fitting, nets can be used to proof installations such as air conditioning units on roofs.

Whatever the installation, the same basic principles apply. A tensioned cable is fitted to the perimeter of the area to be proofed; the tension being supplied through the use of barrel strainers. The cable is

attached at the corners to netbolts using special ferrules or wire rope grips. Netbolts are also used at 10 metre intervals to attach support cables. Intermediate fittings are installed at regular intervals to keep the cable close to the structure. The spacing of these intermediate fixings will vary according to the species of bird. Gulls and pigeons will need 1.0m spacing, starlings 0.5m and sparrows 0.3m. The net is attached to the cable with hog rings, using hog ring pliers. As a general rule, one hog ring per square is required.

Access behind the nets can be provided by installing either net zips, net clips or the flexible rod system. The attachments listed above come in various forms to suit different situations and substrates.

Corner fixing Barrel strainer Hog rings Ferrules Intermediate fixing

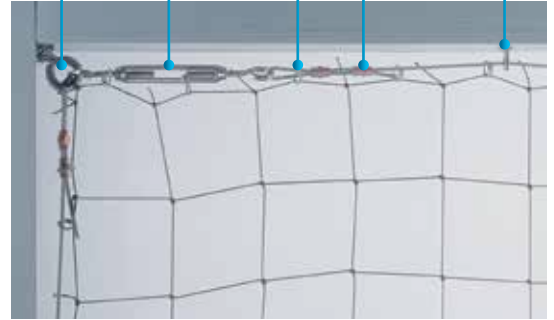

Sparrow	19mm (3/4")
Starling	28mm (1 1/8")
Pigeon	50mm (2")
Gull	75mm (3")

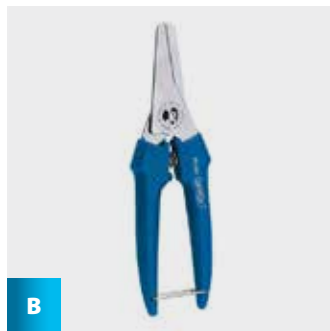
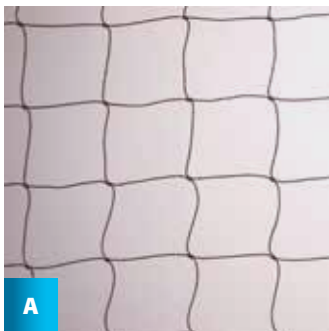

NEW

A "NO-FLAME" BIRD NETTING

Knotted polyethylene, made with UV light-stabilised, flame retarded 12/6 twine. This netting will not propagate a flame and meets BS55867 Performance specification (under BS5438 test method) A useful alternative to offer as an extra specification to suggest to clients

NET19NOFLAME	Black 19mm (3/4") mesh	Square Metre	
NET50NOFLAME	Black 50mm (2") mesh	Square Metre	

B NET SHEARS

Essential tool for cutting and trimming nets. Blades manufactured from stainless steel, hardened and tempered to give long life. Bottom blade edge is serrated to improve grip during cutting. The moulded grip handles are spring-loaded and incorporate a handle clip. For use on thin steel, copper and Aluminium sheet, carpet, rubber, plastics and leather.

NETSHEARS	Each	
------------------	------	--

C BIRD NETTING ZIP

NETZIPBLK1M	Black 1m length	
NETZIPBLK2M	Black 2m length	

D BIRDSCAPE

The Birdscape humane netting escape funnel is a unique one-way funnel which acts as an escape route for unintentionally trapped birds. Quick and easy to install into any size netting using hog ring staples.

- One-way funnel lets birds leave and stops them returning.
- Quick and easy installation.
- Prevents negative publicity for bird control.

BIRDSCAPE5	Pack of 5	
-------------------	-----------	--

NEW

BIRD NETTING

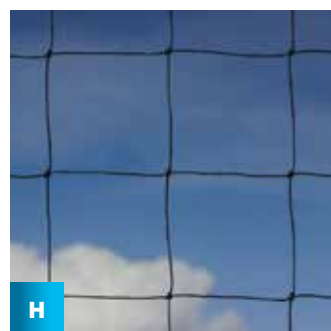
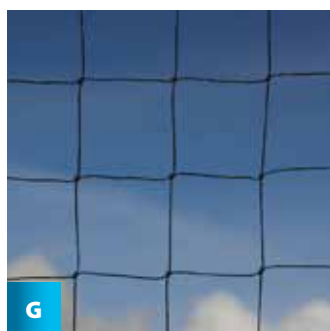

E 19MM SPARROW NETTING

NET19BLACK	Black	Square Metre	
NET19STONE	Stone	Square Metre	
NET19TRANS	Translucent	Square Metre	
NET19B5X5	Black	5m x 5m	
NET19B10X10	Black	10m x 10m	
NET19B15X15	Black	15m x 15m	
NET19B20X20	Black	20m x 20m	

F 28MM STARLING NETTING

NET28BLACK	Black	Square Metre	
------------	-------	--------------	--

G 50MM PIGEON NETTING

NET50BLACK	Black	Square Metre	
NET50STONE	Stone	Square Metre	
NET50TRANS	Translucent	Square Metre	
NET50B5X5	Black	5m x 5m	
NET50B10X5	Black	10m x 5m	
NET50B10X10	Black	10m x 10m	
NET50B15X5	Black	15m x 5m	
NET50B15X10	Black	15m x 10m	
NET50B15X15	Black	15m x 15m	
NET50B20X10	Black	20m x 10m	
NET50B20X15	Black	20m x 15m	
NET50B20X20	Black	20m x 20m	

H 75MM GULL NETTING

NET75BLACK	Black	Square Metre	
------------	-------	--------------	--

BIRD NETTING FIXINGS

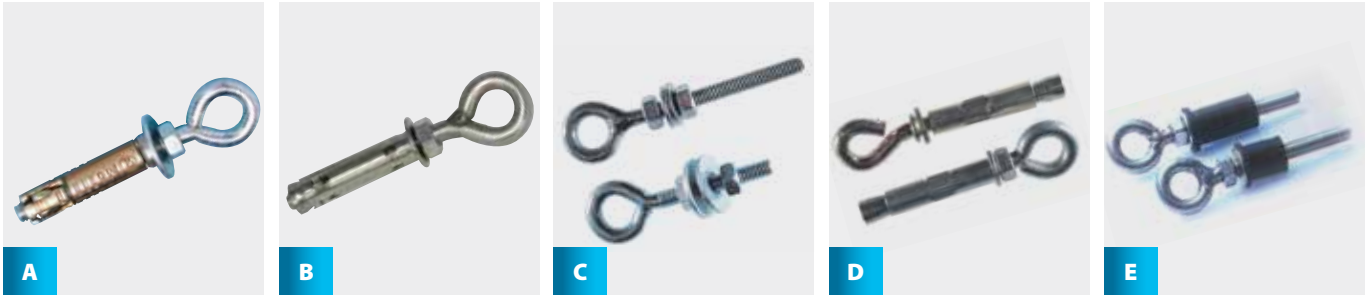

A M6 NETBOLTS

For corners and to secure cross wires on most nets. Heavy weight expansion bolts.

NETBOLT6GALV	Standard M6 galvanised steel Netbolt (10mm Drill Bit)	Pack of 10	
NETBOLT6STST	M6 Forged stainless steel Netbolt (10mm Drill Bit)	Pack of 10	

B M8 NETBOLTS

For runs of straining wire exceeding 10m between corner fixings or for exposed horizontal net greater than 20m, you will need to use the larger M8 bolts. (14mm drill bit)

NETBOLT8GALV	Standard M8 galvanised steel Netbolt	Pack of 10	
NETBOLT8STST	M8 Forged stainless steel Netbolt	Pack of 10	

C BEAM BOLTS

Eyebolts with 2 nuts and washers for attachment to the flanges of girders. Available in both yellow passivated galvanised form or 316-grade stainless steel.

BEAMBOLTGALV	Stainless steel beam bolt (6.5mm HSS Drill)	Pack of 10	
BEAMBOLTSTST	BZP beam bolt (6.5mm HSS Drill)	Pack of 10	

D MINI BOLTS

For small nets these expanding fixings can be used for the corners. Alternatively they could be used as strong intermediate fixings. (8mm Drill Bit).

MINIBOLTGALV	Galvanised steel minibolt	Pack of 10	
MINIBOLTSTST	Stainless steel minibolt	Pack of 10	

E CLADDING BOLTS

Eyebolts with expanding rubber nuts for fixing to thin metal cladding or into soft or brittle building substances. (13mm Drill Bit).

CLADBOLTSMGALV	Galvanised small	Pack of 10	
CLADBOLTSMSTST	Stainless steel small	Pack of 10	
CLADBOLTLASTST	Stainless steel large	Pack of 10	

BIRD NETTING FIXINGS

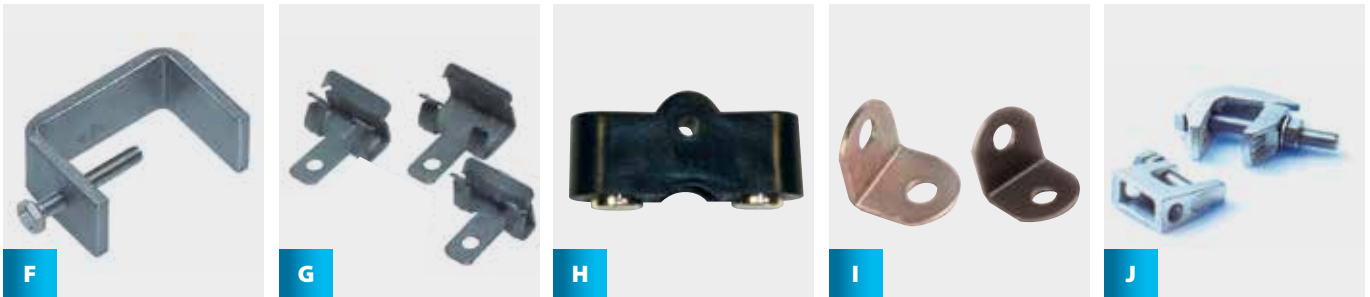

F GIRDER CLAMPS

For girders, which have flanges between 20mm & 50mm thick, bolt on clamps are available. Made of 316-grade stainless steel.

GIRDCLAMP50MM	50mm Girder clamp (For flanges 20 - 50mm)	Pack of 10	
----------------------	---	------------	--

G GIRDER CLIPS

To fit straining wires or weld mesh panels to girders where it is not possible to drill or use cartridge tools. Made of galvanised steel.

GIRDCLIP4-8	4H24 (Flange thickness 3 - 7mm)	Pack of 100	
GIRDCLIP8-14	4H58 (Flange thickness 7 - 13mm)	Pack of 100	
GIRDCLIP14-20	4H912 (Flange thickness 13 - 20mm)	Pack of 100	

H NET MAGNETS

Intermediate fixings for metal substrates. They are extremely quick to fix in place, can be useful for following contours of a metal substrate, with or without straining wire. Wire can be retained under the bridge or passed through the hole.

Dimensions: 45mm long x 15mm wide x 22mm high with a 3.5mm diameter hole. Net Magnets can be used on:

- Metal structures such as silos
- Profile metal cladding
- I beams, girders and stanchions on bridges and canopies

NETMAG10	Pack of 10	
-----------------	------------	--

I STEEL ANGLE BRACKETS

Steel angle brackets, available in either a galvanised finished or in 316-grade stainless steel.

ANGBRACKGALV	Galvanised Angle Brackets	Pack of 100	
ANGBRACKSTST	Stainless Steel Brackets	Pack of 100	

J BRIDGE CLAMPS

Substantial galvanised fixings for attaching nets to the underside of bridges. The BRIDGE CLAMP for beam flanges up to 20mm thick.

BRIDGECLAMP10	Bridge clamp	Pack of 10	
----------------------	--------------	------------	--

INTERMEDIATE FIXINGS

**A NETSPIKE**

A simple intermediate fixing, drill a 5mm hole and fix in. Available in galvanised and stainless steel.

NETSPIKEGALV	Galvanised steel	Pack of 100	
NETSPIKESTST	Stainless steel	Pack of 100	

B STAINLESS STEEL SPLIT PIN

Masonry anchor fixing, available in 38mm, designed for use with masonry rivets. Stainless steel.

SPLITPIN38MM	Pack of 100		
---------------------	-------------	--	--

C NYLON ANCHOR RIVET

38mm Anchor Rivet, designed to fit bird posts and split pins. 6.5mm drill bit required for fitting.

ANCHRIVET38MM	Pack of 100		
----------------------	-------------	--	--

D SCREWPIN

35mm Stainless Steel Screwpin, designed for use as an intermediate fitting. Can be used with either wood or masonry plugs, using a 6mm drill bit.

SCREWPIN100	Pack of 100		
--------------------	-------------	--	--

E SCREW EYE

40mm screw eye, designed as an intermediate fixing for wood or masonry, red plug required. Available in galvanised and stainless steel. 6mm Drill Bit required.

SCREWEYEGALV	Galvanised steel	Pack of 100	
SCREWEYESTST	Stainless steel	Pack of 100	

BIRD NETTING FIXINGS

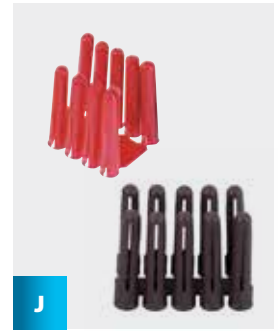
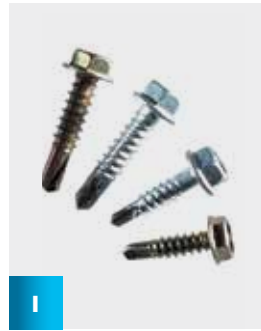
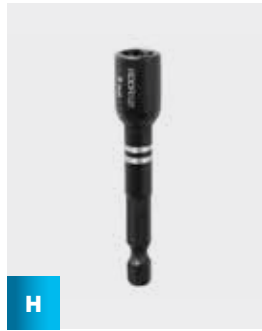
**F "S" CLIPS**

The S Clip can be used to compliment the flex rod system when used as an access point into a net. Also as a replacement for hog rings when short term access through a net is required.

SCLIP200

Pack of 200

G MULTI USE CABLE BRACKET

A versatile stainless steel bracket that is screwed into position. Wire rope can be threaded through the hole or supported over the "hook". Barrel Strainers can be hooked into the hole if it is used as a corner fixing on a small net.

MULTIBRACK100

Pack of 100

H HEX DRIVE SOCKET

Professional grade impact nut driver designed to withstand the toughest fastening applications. The powerful magnet allows for a secure grip and unyielding bit engagement. Ideal for use on hex head screws when installed with an impact driver. Designed to withstand the sudden rotational and downward forces exerted by an impact driver.

SCREWHEX

Each

I SELF DRILL SCREWS

The Self Drill screws can be installed using a Hex Drive Socket into steelwork up to 5mm thick. Available in galvanised and stainless steel.

SCREW19MMGALV

19mm Galvanised

Pack of 100

SCREW32MMGALV

32mm Galvanised

Pack of 100

SCREW25MMSTST

25mm Stainless

Pack of 100

SCREW38MMSTST

38mm Stainless

Pack of 100

J WALL PLUGS

For use with screw eyes and screw pins when using in masonry. Red plug for 6mm drill bits, Brown plug for 7mm drill bits.

REDWALLPLUGS

Red

Pack of 100

BROWNWALLPLUGS

Brown

Pack of 100

NET STRAINING WIRE AND ACCESSORIES



A

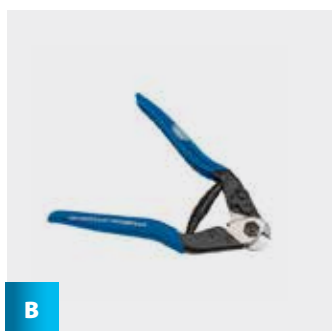

B



C

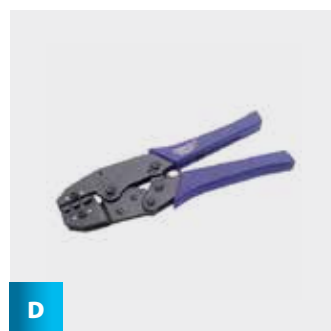

D

A WIRE ROPE

For most nets, 2mm diameter wire rope is used, though other sizes are available for very large or very small nets. 3mm diameter wire cannot be crimped - you need to use 3mm wire rope grips. For flexibility, the 7/7 (49-strand) type is advised. This wire is available in galvanised steel, though it is advised that 316-grade stainless steel be used in corrosion-resisting systems.

WIRE2MMGALV200MM	2mm 7/7 Galvanised	200m	
WIRE3MMGALV100MM	3mm 7/7 Galvanised	100m	
WIRE2MMSTST200MM	2mm 7/7 Stainless Steel	200m	
WIRE3MMSTST100MM	3mm 7/7 Stainless Steel	100m	

B WIRE CUTTERS

Expert Quality, for the cutting of wire rope up to a maximum diameter of 5mm and spring wire up to 1.5mm diameter. SK5 high carbon steel blades hardened, tempered and polished. Spring-loaded handles with vinyl grips and safety lock.

WIRECUTTER	Each		
-------------------	------	--	--

C FERRULES

RATCHET CRIMPING TOOL REQUIRED.

FERALU2.5MM	2.5mm Aluminium (For use with 2mm Galv. wire)	Pack of 100	
FERCOPPER2.5MM	2.5mm Copper (For use with 2mm S/S wire)	Pack of 100	

D RATCHET CRIMPING TOOL

Specially designed for crimping 2.5mm ferrules to the wire rope.

RATCHTOOL	Each		
------------------	------	--	--

BIRD NETTING FIXINGS



E



F



G

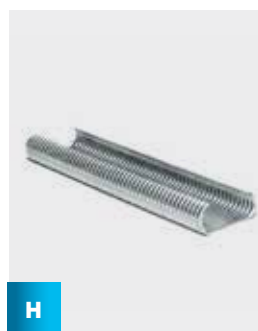

H

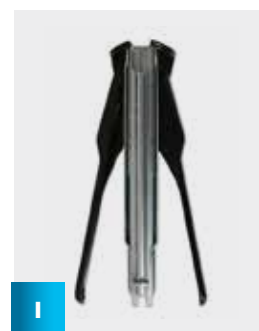

I

E WIRE ROPE GRIPS

These are available in either galvanised or stainless steel. They can be used with either 2mm or 3mm diameter wire. The wire rope grips are tightened using a nut spinner, 7mm size for galvanised wire rope grips and 5.5mm size for the stainless steel ones.

ROPEGRIPGALV100	3mm grip, galvanised	Pack of 100	
ROPEGRIPSTST10	3mm grip, stainless steel	Pack of 10	

F 7MM NUT SPINNER

Chrome vanadium steel blades hardened, tempered with satin chrome plated finish. Each socket has a hex on the base providing extra grip when more torque is required. Fitted with soft grip handles with moulded inserts

NUTSPIN7MM	Each		
-------------------	------	--	--

G BARREL STRAINERS

The wire is tensioned by the use of Barrel Strainers. The standard size used is M6, which will tension up to 10m of 2mm wire rope.

BARSTRM6GALV	M6 Galvanised Barrel Strainer	Pack of 10	
BARSTRM8GALV	M8 Galvanised Barrel Strainer	Pack of 10	
BARSTRM6STST	M6 Stainless Steel Barrel Strainer	Pack of 10	
BARSTRM8STST	M8 Stainless Steel Barrel Strainer	Pack of 10	

H HOG RINGS

Hog rings are key to fixing nets to the wire rope. Available in three versions.

HOGRINGGALV	P7 Hog Ring 18mm Staples galvanised	Pack of 2500	
HOGRINGALU	P7 Hog Ring 18mm Staples aluminium	Pack of 2500	
HOGRINGSTST	P7 Hog Ring 18mm Staples stainless steel	Pack of 2500	

I HOG RINGER

Single handed hog ring pliers, featuring automatic feed.

HOGRINGER	Each		
------------------	------	--	--

SPECIAL FIXINGS



A



B



C



D

A NET RIDGE BRACKETS

These also hold the net wire above the ridge. As with the Roof Spike, the wire will need strong anchorage points at either end to strain off, which will probably need to be fabricated specially, but these brackets will keep the wire off the ridge. Made from 316-grade stainless steel. 450mm in length.

RIDGEBRACK

Each

B TWO WAY SLATE BRACKET

Slips between adjoining slates to hold the wire rope close to the surface of the roof. It is designed to allow the wires to be attached horizontally or vertically.

SLATEBRACK10

Pack of 10

C PRO EXTERNAL CORNER FIXING BRACKET

When running a straining wire around a corner it can be difficult getting a fixing close to the corner to prevent damaging the straining wire or the building. This bracket will help solve this problem. Thanks to the angle of the hole, this bracket can also be used to fit a wire neatly up an outside corner of a building. Fixing holes 6mm diameter.

CORNFIXBRACK

Each

D STANDING SEAM CLAMP

Standing seam roofs are becoming increasingly common for factories and warehouses. The roof panels are joined with seams that protrude vertically above the roof. As the roofs are becoming common, so are the infestations of Gulls on them. The new standing seam clamp provides a secure means of fixing net straining wires directly onto these standing seam roofs or for anchoring mounting brackets such as the roof mount. The clamp requires a 6mm allen key driver to fasten in place. They are made from tough extruded aluminium with stainless steel allen screws and spring washers. The top plate, measuring 100mm x 40mm, comes with no holes, but being aluminium can easily be drilled as required.

SEAMCLAMP

Each

SPECIAL FIXINGS

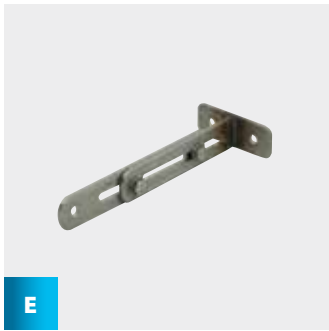

E



F

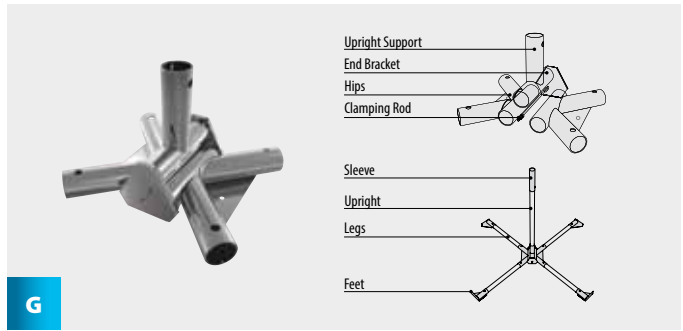

G

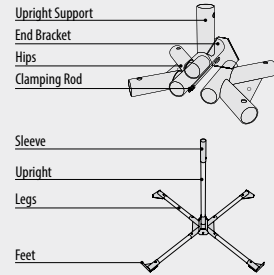

E PRO 'NET OFF' SLIDER

This bracket will support straining wire 105mm to 210mm from the substrate in places where the net needs to be held away from a protrusion to help prevent abrasion damage to the net. Fixing holes 6mm diameter. Tighten the nuts with 10mm spanners.

NETOFFSLIDE	Each	
--------------------	------	--

F DORMER BRACKETS

Standard brackets for installing a bird net system made from stainless steel.

DORMCORNER	Corner Dormer Bracket	Each	
DORMINTER	Intermediate Dormer Bracket	Each	

G ROOF MOUNTS

Increasingly, large roofs are being proofed to protect against pigeons and gulls. In most circumstances it is not feasible to drill into the roof itself, so net supports that can be weighed down are required. As no two roofs are the same, the supports need to be adaptable to fit different roof shapes, angles and obstacles. The new roof mount far exceeds these criteria. It is light-weight, very easy to handle, extremely versatile and allows fast installation.

Please contact the Killgerm Sales office for further information.

ROOFMBASE	Roof Mount Base	Each	
Includes: Main assembly (2 hips, 1 upright support, 2 end caps, 1 clamping rod), 4 x feet and 10 x 19mm screws			
ROOFMLEGS	Roof Mount Legs	Each	
Includes: 4 x legs			
ROOF1MPOLE	Roof Mount 1 metre Upright	Each	
Includes: 1 x 1 metre pole and 1 x sleeve			
ROOF2MPOLE	Roof Mount 2 metre Upright	Each	
Includes: 1 x 2 metre pole and 1 x sleeve			



NET Support System (NSS)

The NSS range has been designed by professionals to meet the needs of netting projects, from the most basic to the more complicated installations.

The NSS range provides single plate brackets to suit face and corner situations, each 500mm in height (NSS101 – NSS108). To compliment this range, a similar design for double plate stanchions is available at 1000mm height. (NSS112 – NSS116) The option to extend the twin plate range with an additional 500mm or 1000mm is also available.

Whilst these brackets may be attached into cladded sub-straights, three smaller 75mm x 75mm square cladding brackets (NSS109 – NSS111) are a useful alternative to cladding bolt fixings where weight and strength needs to be considered.

All of our NSS stanchions are hot dipped galvanised making

them resistant to rust. The uprights are manufactured in 40mm x 40mm box section and welded onto a 3mm fixing plate which will accommodate a number of fixings to suit most sub-straights.

The NSS range also includes a range of three non-piercing roof stanchions, from a single boot base support to a double 450mm x 450mm x 40mm or four slab systems. (NSS118 – NSS120) Also to compliment the roof range, a smaller 250mm x 250mm two slab ridge bracket (NSS121) is available.

In addition a hand rail stanchion has been designed to fit onto any static safety handrail system. This is available in 2000m height.

A specialist hot dipped galvanised door frame is also available. (NSS122).

PLEASE NOTE THAT AN EXTENSION CANNOT BE ADDED TO SINGLE PLATE STANCHIONS, ONLY DOUBLE PLATED STANCHIONS.

NSS 101



External or internal face intermediate bracket. Height 500mm

NSS101

Each

NSS 102



External or internal face intermediate short 50mm extension bracket. Height 500mm

NSS102

Each

NSS 103



External face intermediate long 200mm extension bracket. Height 500mm

NSS103

Each

NSS 104



External short 75mm extension corner bracket. Height 500mm.

NSS104

Each

NSS 105

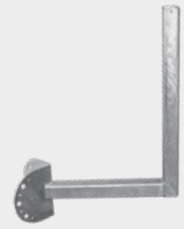

External corner long 300mm extension bracket. Height 500mm

NSS105

Each

NSS 106



Internal flush corner bracket. Height 500mm.

NSS106

Each

NSS 107



Internal short 50mm extension corner bracket. Height 500mm.

NSS107

Each

NSS 108



Horizontal or cap face intermediate bracket. Height 500mm.

NSS108

Each

NSS 109



Internal cladding corner bracket. Each side 75mm x 75mm.

NSS109

Each

NSS 110



External or internal cladding face bracket. 75mm x 75mm.

NSS110

Each

NSS 111



External cladding corner bracket. Each side 75mm x 75mm.

NSS111 Each

NSS 112



Double plate fix intermediate flush extension bracket. Height 1000mm

NSS112 Each

NSS 113



Double plate fix external / internal short 50mm extension face bracket. Height 1000mm

NSS113 Each

NSS 114



Double plate fix external short 75mm extension corner bracket. Height 1000mm

NSS114 Each

NSS 115



Double plate fix internal flush extension corner bracket. Height 1000mm

NSS115 Each

NSS 116



Double plate fix internal short 50mm extension corner bracket. Height 1000mm

NSS116 Each

NSS 117



Hand rail stanchion. Height 2000mm each (made up of two by 1000 sections & includes two clamp fixing brackets).

NSS117 Each

NSS 118



Single base roof stanchion. Height 1000mm. Compatible Polyethylene, Polypropylene, base unit for most roof surfaces.

NSS118 Each

NSS 119



Two slab roof stanchion unit. Height 1000mm. Requires two 450mm x 450mm concrete slabs (Obtain locally)

NSS119 Each

NSS 120

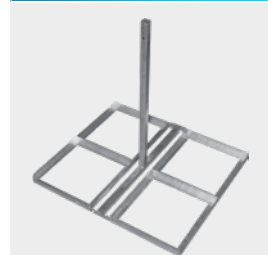

Four slab stanchion unit. Height 1000mm. Requires 4 x 450mm x 450mm concrete slabs. (Obtain locally)

NSS120 Each

NSS 121



Free standing ridge bracket unit. Height 400mm. Requires 2 x 250mm x 250mm concrete slabs (Obtain locally)

NSS121 Each

NSS 122



Heavy duty door. 2000mm x 830mm (Includes latch)

NSS122 Each

NSS 123



500mm extension

NSS123 Each

NSS 124



1000mm extension

NSS124 Each

PLEASE NOTE THAT NSS BRACKETS ARE NOT STOCK ITEMS & ARE MADE TO ORDER. PLEASE CONTACT OUR SALES OFFICE TO CONFIRM LEAD TIMES.



NSS PROTECTION CAPS

NSSPROTCAP20 Pk 20



NSS TUBE INSERTS

NSSTUBEINS5 Pk 5

PLEASE NOTE CARRIAGE WILL BE CHARGED AT COST. PLEASE CONTACT THE KILLGERM SALES OFFICE FOR MORE INFORMATION.

SPIKE SYSTEMS



A



B



C

A DEFENDER NARROW STAINLESS STEEL SPIKES

NEW

UV Stabilised polycarbonate base, temperature resistance with no loss of mechanical strength from -20°C to 130°C . Pins made from corrosion-resistant 304 grade stainless steel.

- 10 stainless steel pins per strip.
- Protects to a maximum of 75mm (3 inches).
- Pattern of 2 rows of pins fanning out at 2 different angles.
- 4 snap points along the base allow the strip to be snapped by hand into smaller sections without needing extra tools.
- Can be installed with glue, screws, nails or cable ties.
- Suitable for pigeons and similar sized birds.
- Each strip is 333mm in length.

DEFNARROW10M	10 metres	
DEFNARROW50M	50 metres	

B DEFENDER WIDE STAINLESS STEEL SPIKES

NEW

UV Stabilised polycarbonate base, temperature resistance with no loss of mechanical strength from -20°C to 130°C . Pins made from corrosion-resistant 304 grade stainless steel.

- 20 stainless steel pins per strip.
- Protects to a maximum of 150mm (6 inches).
- Pattern of 4 rows of pins fanning out at 4 different angles.
- 9 snap points along the base allow the strip to be snapped by hand into smaller sections without needing extra tools.
- Can be installed with glue, screws, nails or cable ties.
- Suitable for pigeons and similar sized birds.
- Each strip is 333mm in length.

DEFWIDE10M	10 metres	
DEFWIDE50M	50 metres	

C DEFENDER EXTRA WIDE STAINLESS STEEL SPIKES

NEW

UV Stabilised polycarbonate base, temperature resistance with no loss of mechanical strength from -20°C to 130°C . Pins made from corrosion-resistant 304 grade stainless steel.

- 30 stainless steel pins per strip.
- Protects to a maximum of 225mm (9 inches).
- Pattern of 6 rows of pins fanning out at 6 different angles.
- 4 snap points along the base allow the strip to be snapped by hand into smaller sections without needing extra tools.
- Can be installed with glue, screws, nails or cable ties.
- Suitable for pigeons and similar sized birds.
- Each strip is 333mm in length.

DEFEXWIDE5M	5 metres	
DEFEXWIDE20M	20 metres	

SPIKE SYSTEMS

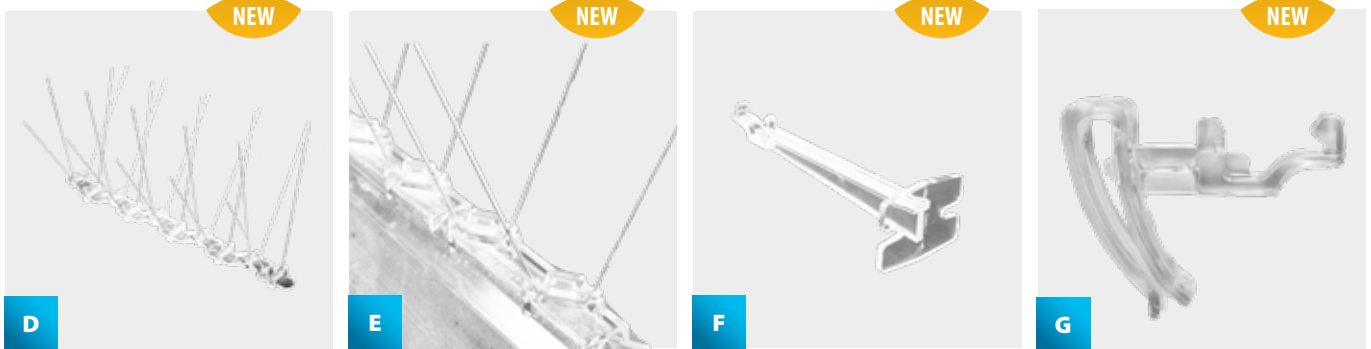
**D DEFENDER GULL STAINLESS STEEL SPIKES**

NEW

UV Stabilised polycarbonate base, temperature resistance with no loss of mechanical strength from -20°C to 130°C. Pins made from corrosion-resistant 304 grade stainless steel.

- 20 stainless steel pins per strip.
- Protects to a maximum of 200mm (8 inches).
- Pattern of 4 rows of pins fanning out at 4 different angles.
- 4 snap points along the base allow the strip to be snapped by hand into smaller sections without needing extra tools.
- Can be installed with glue, screws, nails or cable ties.
- Suitable for pigeons and seagulls.
- Each strip is 333mm in length.

DEFGULL10M	10 metres
DEFGULL40M	40 metres

E DEFENDER RIDGE STAINLESS STEEL SPIKES

NEW

UV Stabilised polycarbonate base, temperature resistance with no loss of mechanical strength from -20°C to 130°C. Pins made from corrosion-resistant 304 grade stainless steel.

- 12 stainless steel pins per strip.
- Fits on any angled ridge from 90degrees to 120degrees.
- Spike at widest part is 80mm.
- Pattern of 2 rows of pins fanning out at 2 different angles.
- Can be installed with glue, screws, nails or cable ties.
- Suitable for pigeons and seagulls.
- Each strip is 333mm in length.

DEFRIDGESM	5 metres
-------------------	----------

F DEFENDER WINDOW CLIPS

NEW

UV Stabilised polycarbonate window clip for several Defender Bird Spikes. 2 clips needed per 33cm spike strip so 6 per metre. Screw onto outside of window and clip the spikes into the clip. You may find it easier to fit the spikes to the clips, then screw the whole assembly onto the window. For use with Defender Wide Stainless Steel Spikes, Defender Gull Stainless Steel Spikes, and Wide Plastic Spikes.

DEFWINDOW50	Pack of 50
--------------------	------------

G DEFENDER GUTTER CLIPS

NEW

UV Stabilised polycarbonate gutter clip for several Defender Bird Spikes. 2 clips needed per 33cm spike strip so 6 per metre. For use with Defender Wide Stainless Steel Spikes, Defender Gull Stainless Steel Spikes, and Wide Plastic Spikes.

DEFGUTTER100	Pack of 100
---------------------	-------------

AVIPOINT™

SPIKE SYSTEMS

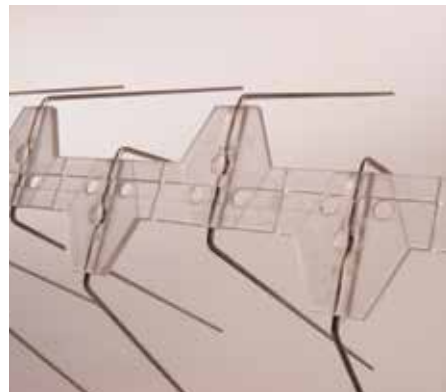
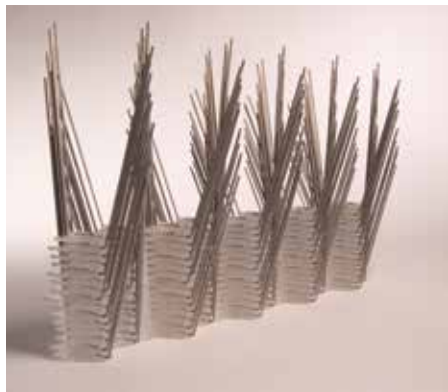

Bird Activity	Daytime perching. Night-time roosting and some nesting areas.	Wires	Heavy - duty 1.4mm, 302 grade stainless steel.
Infestation	From light to heavily infested areas.	Tips of the Wire	Cut flat to prevent injury to the birds and installers.
Where to Use	From the narrowest pipe to the widest building ledges.	Base	UV light protected clear polycarbonate.
Strip Length	33.3cm	Packaging	Packaged in 5m and 50m compact double-walled boxes.

AVIPOINT™ is manufactured in the UK in a highly automated factory using state-of-the-art robotic technology. Installers are assured of consistency of quality and supply. The wires are made from substantial 1.4mm diameter stainless steel, and are cut flat to prevent injury to both installer and birds. The wires are insert-moulded into the base using a unique patented process, which improves durability.

The UV protected polycarbonate base is 33.3cm in length and includes snap lines to allow the strips to be broken down into smaller sections.

With their unique Glue Guide, all the products in the AVIPOINT™ range are exceptionally easy to install. The Glue Guide allows the installer to apply adhesive quickly and easily to the base of the strip using a caulking gun. The guide keeps the glue exactly where it is needed - no mess, no excess. One tube of adhesive will install up to 10m of AVIPOINT™.

AVIPOINT™ Bird Spikes are designed to stack closely inside each other. The stacks are easier to use on site than conventional bundles. This feature also minimises the

amount of space needed to store and transport the spikes. Products are supplied in stacks of 15 strips, sufficient to treat up to 5m of ledge. The stacks also reduce the size of boxes required, thus saving on storage and transport costs. AVIPOINT™ is well protected as the boxes are double walled.



ADHESIVES

Fixall High Tack (Grey)	FIXHITACK290ML	1 x 290ml
Fixall Crystal	FIXCRYSTAL290ML	1 x 290ml

AS A GUIDELINE, ONE TUBE OF GLUE WILL FIX APPROXIMATELY 10 METRES OF SPIKES.

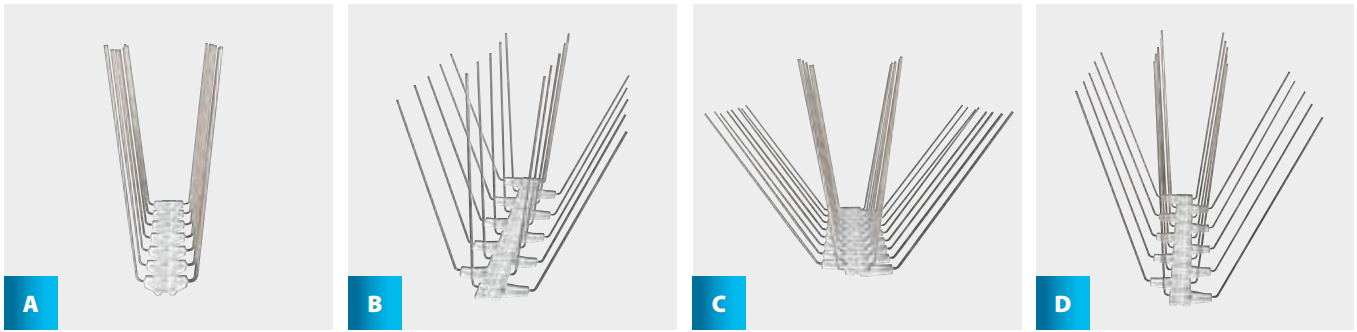

A AVIPOINT™ P14

Ideal for use on pipework or narrow ledges as the base is just 20mm wide. On pipework, we recommend glue and cable tying in place. The spike tips are 50mm apart, so will protect an area up to 115mm wide from one strip. **For use where there is daytime perching of pigeons.**

AVIP14	5 metres	
AVIP14CTN	1 Carton (50 metres)	

B AVIPOINT™ P20

With a denser pattern of 'spikes' spanning a greater width, this is the ideal product for protecting most building ledges. The spike tips are 140mm apart, so will protect an area up to 205mm wide from one strip. **For use in most situations, where birds are perching in the daytime or roosting at night.**

AVIP20	5 metres	
AVIP20CTN	1 Carton (50 metres)	

C AVIPOINT™ P32

With the densest pattern of spikes, this is the product of choice in heavily used areas. The spike tips are 200mm apart, so will protect an area up to 265mm wide from one strip. **For use on wide ledges and areas that are heavily used by pigeons.**

AVIP32	5 metres	
AVIP32CTN	1 Carton (50 metres)	

D AVIPOINT™ G20

Based on the same base as Avipoint™ P20, the G20 spikes are significantly longer. Gull spikes are designed to prevent gulls from landing, so may need to be used in conjunction with gull netting when protecting large areas. The spike tips are 175mm apart, so will protect an area up to 380mm wide from one strip. **For use against gulls.**

AVIG20	5 metres	
AVIG20CTN	1 Carton (50 metres)	

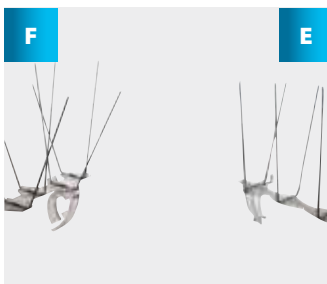

E AVIPOINT™ GUTTER CLIPS

Avipoint™ Gutter Clips can be used to attach the whole range of Avipoint™ to some types of guttering. **Use 2 clips per strip.**

AVIGUTTER	Pack of 10	
-----------	------------	--

F AVIPOINT™ LIPPED GUTTER CLIPS

Aviclips for Lipped Gutters fit securely onto the base of Avipoint P14, P20, P32 and G20 spikes. **Use 2 clips per strip.**

AVILIPPED	Pack of 10	
-----------	------------	--

SPIKE SYSTEMS

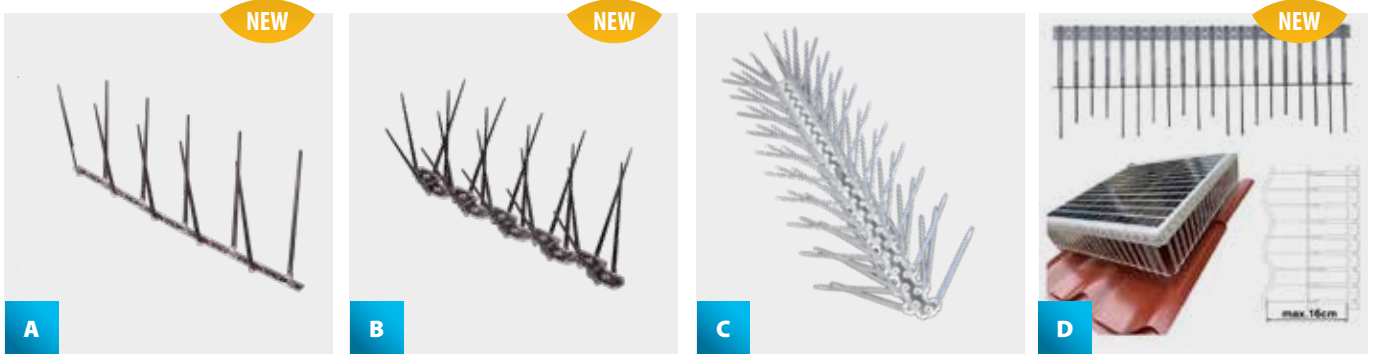

A PLASTIC NARROW SPIKES

The Narrow Plastic Spike is a great product for helping eradicate birds. Any narrow ledge, sill or beam that has a depth of up to 10 cm (4 inches) can be protected from perching, roosting or nesting pigeons and birds. As they are made of a clear polycarbonate plastic, the narrow pigeon spikes become virtually invisible once installed. They are also UV stabilised, so will continue protecting property for years. Each strip is 334mm (13 inches) in length.

PLASTNAR5M	5 meters	
PLASTNAR50M	50 meters	

B PLASTIC WIDE SPIKES

The Wide Plastic Spike is a great product for helping eradicate birds. This anti-roosting pigeon spike will protect ledges up to a depth of 20 cm (8 inches) from the heaviest pigeon infestations. Made from clear polycarbonate plastic, they are also UV stabilised so will continue protecting property for years. Each strip is 334mm (13 inches) in length.

PLASTWIDE5M	5 meters	
PLASTWIDE50M	50 meters	

C THISTLE SMALL BIRD SPIKE

This all polycarbonate spike is the perfect solution for deterring the most determined small bird from perching on commercial or domestic properties. As well as small birds it is very effective against larger birds such as pigeons and seagulls. Each strip measures 33.3cm, and contains 80 pins on each strip. The clear plastic pins span out in 8 different angles creating an impregnable surface that small birds cannot overcome. The pins themselves are half the height of a traditional pigeon spike, giving it a great low profile. The base features silicone fixing holes and break lines if required during installation. Pin height: 62mm. Supplied in packs of 5 metres.

THISTLESPIKESM	5 metres	
-----------------------	----------	--

D STIXX SOLAR FLEX - 160CM

Robust UV stabilised polycarbonate base, featuring 3mm thick, 304 stainless steel pins

- Reinforced bases for extra strength
- Free-falling pins quickly match any roof profile
- Base can be easily snapped to size
- Offers protection on gaps from 80mm - 160mm

STIXX160MM	160mm	50cm strip	
-------------------	-------	------------	--

SPIKE SYSTEMS

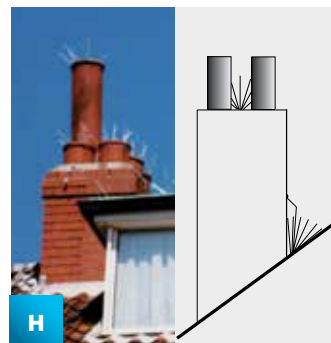
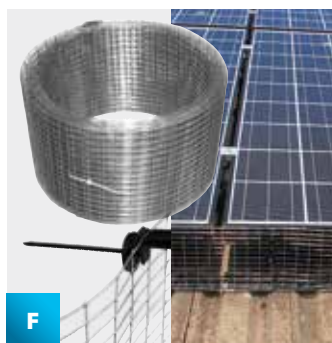
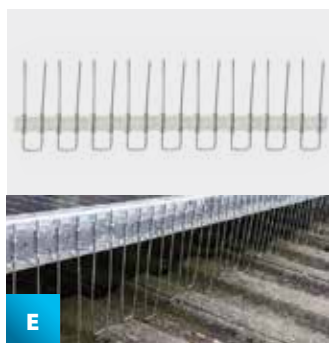

E SOLAR PANEL SPIKES

The Solar Panel Spikes are a convenient solution to proofing solar panel voids and other gaps. They are quick and easy to install, simply apply a bead of adhesive to the surface and adjust the spike to the correct length. Made from UV resistant polycarbonate and stainless steel. Available in 50cm lengths with a choice of 160mm or 210mm spikes. If required, the spikes can be cut using tin snips or good quality pliers.

SOLSPIKE160X50	160mm	50cm strip	
SOLSPIKE210X50	210mm	50cm strip	

F SOLAR PANEL CLIPS

The Solar Panel Proofing is a new system from Killgerm designed to prevent birds from nesting under roof solar panels. It includes a combination of mesh and clips which are easy to install, requiring no drilling. The 19 gauge, 25mm x 12.5mm galvanised mesh is available in 30m x 200mm width rolls. The UV stable polycarbonate clips are supplied in packs of 10 and are designed to fit on the inside lip of the panel without scratching the surface. The clips are fitted two to each corner and then at 500mm points in between.

SOLARCLIP10	Clips	Pack of 10	
SOLARMESH30M	30m Mesh	Each	

G CHIMNEY POT SPIKE

The Chimney Pot Spike has been designed for seagulls, birds and pigeons causing problems on chimney cowls or chimney pots by nesting, perching or roosting. Other than noise and unpleasant mess, if seagulls make nests on chimneys it can become a real fire hazard if the chimney is in use. This pigeon and seagull deterrent is a very easy way to keep seagulls off and out of chimneys. The stainless steel strap is flexible so will fit round or square chimney pots, or around cowls, and will quickly stop seagulls and birds from landing, nesting and causing problems on roofs.

CHIMPOTSPIKE2	Pack of 2	
----------------------	-----------	--

H CHIMNEY SPIKE

Over the last few decades, the incidence of seagulls, such as the Herring Gull and the Lesser Black-Backed Gull, nesting on roofs has increased dramatically, causing enormous problems for those living or working below. The Chimney Spike has been developed to help overcome these problems, particularly for residential properties. The Chimney Spike is made from stainless steel, for maximum corrosion resistance. The ends of the 12" (300mm) long spikes are cut square, so the birds are not harmed - just frustrated!

The Chimney Spike is supplied "flat packed" for erection on site. It is easily bent into a "crown" of repellent spikes, using no more than a pair of pliers. The Chimney Spike can be fixed in place with sand and cement mortar, or it can be secured with a suitable screw and wallplug. **WARNING** - The Chimney Spike is best installed outside the breeding season, which runs between April and August in Europe. If work starts during this time, you can expect to be attacked by the birds, so all necessary safety precautions must be taken.

CHIMSPIKE	Each	
------------------	------	--

BIRDWIRE SYSTEM

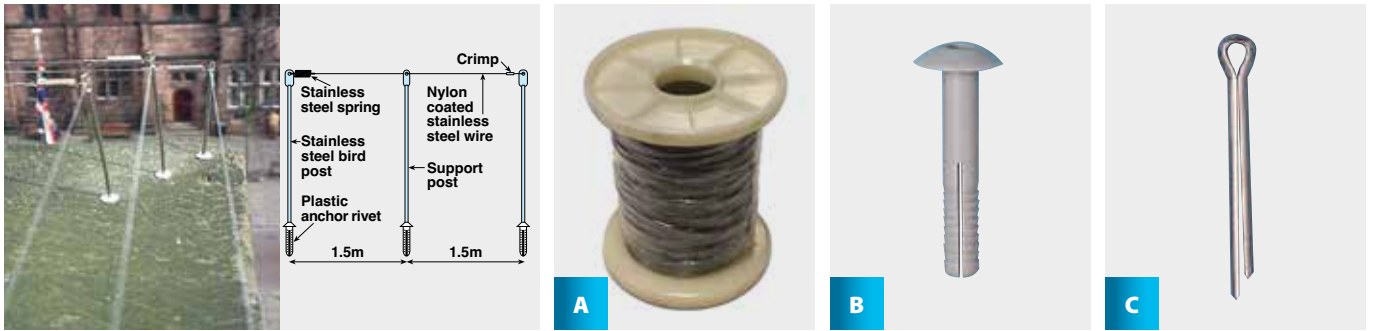

Pigeons LOW to MEDIUM PRESSURE
Seagulls LIGHT PRESSURE (with Gullwire components)

- The Birdwire system is still one of the most widely used anti-perching systems for pigeons.
- All components are made of stainless steel for maximum corrosion resistance.
- The benefits of using this system are its flexibility and economy, as it can be adapted for use in virtually any situation and it offers ledge protection at a cost lower than most other systems.
- As with any bird-proofing system however, if it is used in the wrong situation, or if it is incorrectly installed, highly persistent pigeons may find ways to overcome it. Superficially it appears to be a very simple system to install, but special techniques need to be employed to ensure success.
- These techniques are best learned by attending a suitable training course.

A BIRDWIRE

Seven-stranded stainless steel wire coated with UV protected clear nylon to give a diameter of 0.7mm with a breaking strain of 22 kgs.

BIRDWIRE100M	Birdwire	100m roll	
BIRDWIRE300M	Birdwire	300m roll	

B BIRDWIRE ANCHOR RIVETS

Made from high impact thermoplastic nylon. The dome shaped head helps to keep rainwater out of the drilled hole.
 For use with both 110mm and 150mm bird posts. **(6.5mm Drill Bit)**

ANCHRIVET25MM	25mm (1") Anchor Rivet, Grey	Pack of 100	
----------------------	------------------------------	-------------	--

C BIRDWIRE STAINLESS STEEL SPLIT PINS

Where suitable surfaces exist, split pins can be used instead of bird posts, such as in window reveals or to vertical stonework at the ends of ledges.

SPLITPIN25MM	25mm (1") Birdwire Split Pin	Pack of 100	
---------------------	------------------------------	-------------	--

BIRDWIRE SYSTEM

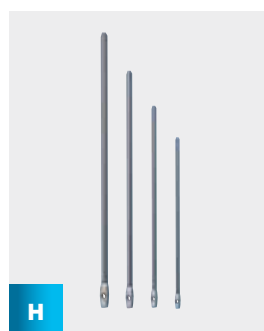
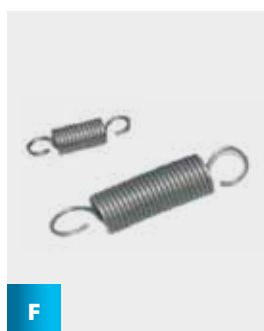
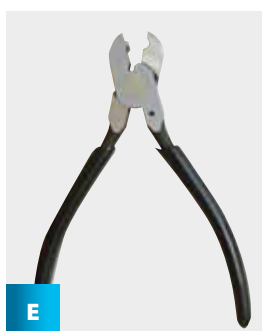

D BIRDWIRE CRIMPS

Nickel-plated copper for forming the end loops in the wire attached to the posts and springs.

BIDRCRIMP	Birdwire Crimps	Pack of 100	
FERCOPPER1MM	1mm Copper Ferrules	Pack of 100	

E BIRDWIRE CRIMP & CUTTER TOOL

A specially designed dual purpose tool used to cut the wire and secure the crimps.

CRIMPTOOL	Each		
------------------	------	--	--

F BIRDWIRE SPRINGS

For Medium Pressure sites or where a low visibility system is required, the small spring is recommended.

SPRINGSMALL100	Small	Pack of 100	
SPRINGLARGE100	Large	Pack of 100	

G BIRDWIRE STICK ON POSTS

Made from UV stabilised grey nylon, these surface mounts can be used with a range of bird wire posts or as an intermediate net fixing. The surface mounts can be fixed using adhesive where no drilling is allowed or can be fixed/screwed using the 4 pre-formed holes. These mounts can be used on a range of surfaces including, uPVC, glass, lead flashing, stone, brick, and composite cladding.

POSTPAD10	Pack of 10		
------------------	------------	--	--

H BIRDWIRE STAINLESS STEEL BIRD POSTS

Birdwire Stainless Steel Bird Posts for bird wire systems. Use with anchor rivets or bird wire stick on posts. Made from 4mm 304 stainless steel. Available in 4 lengths. The leading edge post is normally the 125mm size, with the 150mm size used for rows behind.

BIRDPOST95MM	95mm (3.75") x 4mm	Pack of 100	
BIRDPOST125MM	125mm (5") x 4mm	Pack of 100	
BIRDPOST150MM	150mm (6") x 4mm	Pack of 100	
BIRDPOST180MM	180mm (7") x 4mm	Pack of 100	

BIRDWIRE SYSTEM

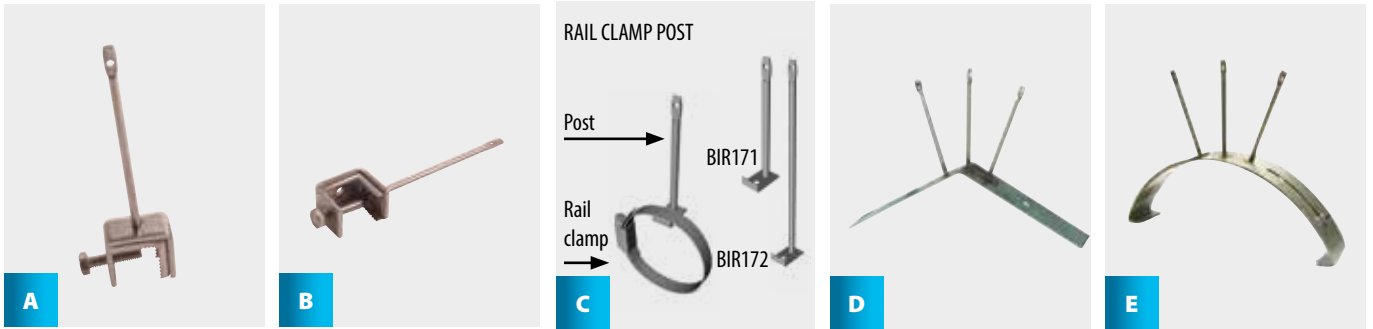

A BIRDWIRE GUTTER POST

A stainless steel birdwire post fixed to a clamp which allows the birdwire system to be fixed to the leading edge of a gutter. 95mm x 4mm.

BIRDGUTPOST Pack of 10

B BIRDWIRE BEAM CLAMP

A stainless steel birdwire post fixed to a clamp which allows the birdwire system to be attached to the flange of a steel beam. Designed for horizontal flanges, girders and beams.

BIRDBEAMCLAMP Pack of 10

C BIRDWIRE RAIL CLAMPS

The two part rail clamps and rail clamp posts allow more functionality: you can now fasten the clamp tightening screw in any position that best suits the installation. The rail clamp posts can be used separately for installation onto cladding by screwing in place through the 5mm fixing hole in the base.

BIRDCLAMPPIG	Pigeon Rail Clamp Post	Pack of 10	
BIRDCLAMPGULL	Gull Rail Clamp Post	Pack of 10	
BIRDCLAMP45-60	Rail Clamp, 45 - 60mm diameter	Pack of 10	
BIRDCLAMP60-80	Rail Clamp, 60 - 80mm diameter	Pack of 10	
BIRDCLAMP90-120	Rail Clamp, 90 - 120mm diameter	Pack of 10	

D BIRDWIRE RIDGE BRACKETS

A Birdwire post fixed to a clamp which allows the Birdwire system to be attached to ridges.

RIDGEBRACK3X95	3 x 95mm posts	Each	
RIDGEBRACK3X200	3 x 200mm posts	Each	

E HALF ROUND RIDGE BRACKETS

A Birdwire post fixed to a clamp which allows the Birdwire system to be attached to ridges.

RIDGEROUND3X95	3 x 95mm posts	Each	
RIDGEROUND3X200	3 x 200mm posts	Each	

TRAPS

**F** KC77 LARGE PIGEON TRAP

Made from welded mesh with sheet metal galvanised base, two bob wire entrances and door in the top.
 Flat pack design and easy assembly on site. Trapped birds are removed through top door.
 Constructed from 50mm x 50mm (2" x 2") 12swg welded mesh.
 Zinc plated finish. Weight 5.0 kilos.

KC77TRAPS	1020mm x 610mm x 310mm	
------------------	------------------------	--

G KC77FUNNEL	Ground Funnel Entrance	
----------------------------	------------------------	--

ADHESIVES

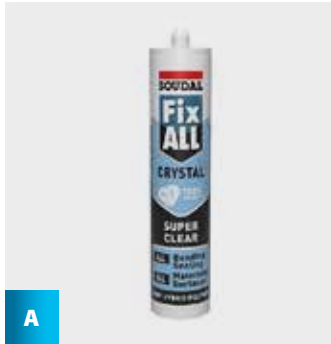

A



B



C

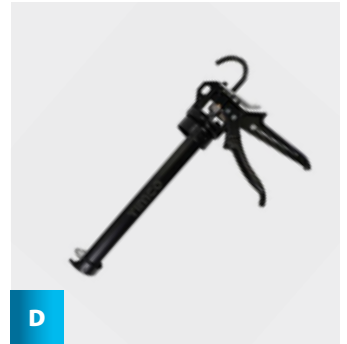

D

A FIXALL CRYSTAL

Hybrid polymer sealant adhesive. 100% CRYSTAL clear sealant, adhesive and filler, based on SMX Hybrid Polymer technology. Suitable for internal and external use. Can be applied in all weather conditions. Primerless adhesion on most construction materials, including wet and damp surfaces. Contains XS1 fungicides providing ultimate mould resistance.

FIXCRYSTAL300ML 1 x 300ml

B SURFACE CLEANER

Surface Cleaner is a universal solvent cleaner designed for use prior to the application of adhesives.

SURFCLEAN500ML 1 x 500ml

C CARTRIDGE CUTTER

Simplify the handling of silicon cartridges with the cap and spout trimmer. It saves time and reduces the risk of injury from open blades.

KGA001 Each

D PROFESSIONAL SEALANT GUN

A 48mm heavy duty sealant and caulking gun.

- Swivel action barrel for easy application into tight corners
- A convenient hook end for hanging
- Patented non-drip mechanism
- 12:1 trigger ratio
- 820g approximate gun weight

PROSEALGUN Each

ANCILLARY BIRD PRODUCTS

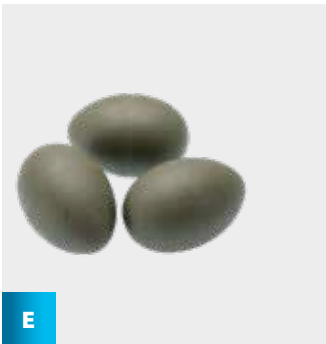

E



F



G

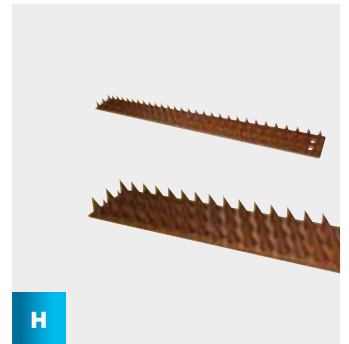

H

E PLASTIC GULL EGG

With gull populations increasing in urban environments, nuisance seagull colonies continue to rise. Research has shown that urban gulls happily accept imitation eggs and will incubate these for twice the normal incubation time, allowing seagull populations to decline naturally. These imitation eggs are made of plastic and are weighted with sand so that they look and feel authentic. Size: 60mm x 44mm, Weight: 60g (e)

Plastic imitation eggs are easy to deploy, require fewer rooftop visits and can be re-used each year. Imitation eggs can reduce aggression in Lesser Backed and Herring Seagulls. Aggression happens when the young birds are leaving the nest. By replacing the real eggs at the start of the season noise and nuisance levels are noticeably reduced. Plastic imitation eggs have a higher success rate of controlling gull populations than traditional methods such as egg oiling. It is also less messy and more cost effective. Repeated replacement of imitation eggs each breeding season, ultimately reduces the number of hatchlings and future recruits within treated areas. Nuisance populations in treated areas will decline in the long term in an environmentally friendly and humane manner.

GULLEGG

Each

F THE DADDI LONG LEGS™ SYSTEM

Pigeons

LIGHT to MEDIUM PRESSURE

Seagulls

LIGHT PRESSURE

This is a unique bird-repelling product, which uses a rotating system of long stainless steel wires, which wave about in the wind or when a bird comes into contact with them. The Daddi Long Legs System can either be screwed into position, or it can be glued using the Stick On base, using a glue such as FIXALL. To re-install, simply force the lock-washer up inside the housing with a screw-driver.

DADLONG4FOOT	4' (1.3m) diameter	Each	
DADLONG8FOOT	8' (2.4m) diameter	Each	

G WELDMESH

Available in two sizes, one for mice and one for pigeons. Width = 0.9 metres. Also available are clips for attaching the weldmesh.

MESH6M25MM	25mm x 25mm	6 metre roll	
MESH6M6.5MM	6.5mm x 6.5mm	6 metre roll	
MESHCLIPS50	Pack of 50		

H PRICKLER STRIP

The Prickler Strip consists of an array of closely arranged cones formed from weather-proof PVC. Designed to deter prowlers and predators, without harm, and can be screwed or glued. Size 460mm x 48mm. Supplied in Brown.

PRICKLERBR46	Brown	Each	
---------------------	-------	------	--

ANCILLARY BIRD PRODUCTS

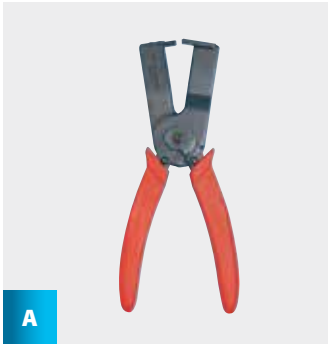

A

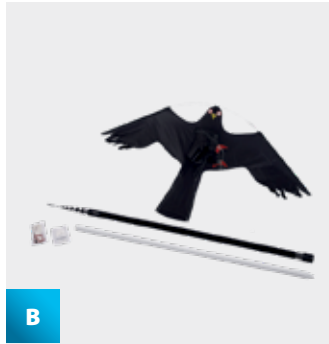

B

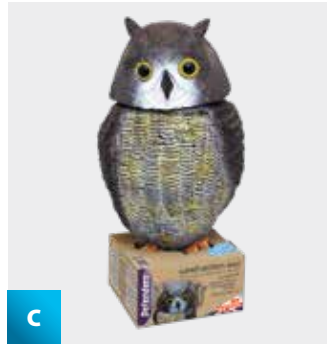

C

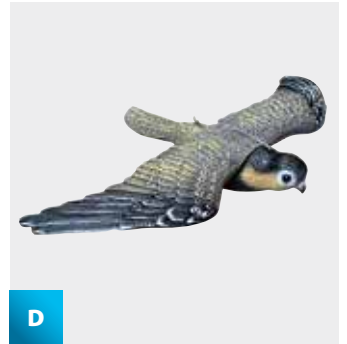

D

A HUMANE BIRD DESPATCHER

This is a special humane despatcher for killing trapped, narcotised or injured birds, by neck dislocation.

BIRDESPATCH Each

B HAWK KITE

- Tethered hawk kite scares pest birds away by constantly weaving and hovering
- Full kit includes kite, telescopic pole and line, full range of spares available
- Highly effective, an ideal solution for playing fields, landfill, industrial roofs etc
- Quick to assemble & low maintenance, however it should not be left out in high winds
- Quietly patrols 24/7 mimics a bird of prey, under which pest birds will not go.
- Protects approximately 20 acres of flat land or 400 square metres of roof area
- Can be used in conjunction with a bio-acoustic deterrent for added effect

HAWK KITE Each

C WIND-ACTION OWL

Rotating head and reflective eyes to deter pests. The Wind-Action Owl is an ideal way to watch over and protect vulnerable garden areas from pests. Set it up using the mounting hole on the base wherever pests are a problem. Wind and reflected light animate the wind-action owl to deter pests naturally.

OWLWIND Each

D FLYING FALCON

Diving bird of prey deters foraging birds from seeds, seedlings, and other vulnerable garden areas. The Flying Falcon comes complete with hanging system for easy set-up in gardens or vulnerable roosting sites in buildings. As it moves in the wind this life-like predator deters other birds naturally and without doing them harm.

FALCONFLY Each

ANCILLARY BIRD PRODUCTS

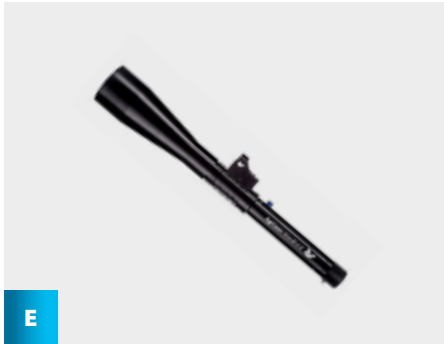

E



F



G

E AGRILASER HANDHELD 100

To make operation over long distances more accurate and safe, the Agrilaser Handheld is equipped with a red dot sight. The sight makes it possible for a bird controller to accurately aim the Agrilaser Handheld at the desired target before activating the laser.

- Easy to use
- Range up to 2,500 meters
- Fast and long-lasting results
- Suitable for repelling most bird species
- Animal and environmentally friendly

To be able to purchase this product, you will need to complete an on-line training course. The course is free of charge, please contact the Killgerm Customer Service Team who will provide the details.

AGRILASERHH Each

F SUPER H POINT .22 PELLETS

The RWS Super-H-Point 0.45g Air Gun pellet is a smooth diablo pellet with a hollow point due to it'd high deformation qualities, it guarantees very good penetration power and maximum shock effect with game. Perfect for hunting.

SUPERH.22PEL Pack of 500

G SUPER H POINT .177 PELLETS

The RWS Super-H-Point 0.45g Air Gun pellet is a smooth diablo pellet with a hollow point due to it'd high deformation qualities, it guarantees very good penetration power and maximum shock effect with game. Perfect for hunting.

SUPERH.177PEL Pack of 500

GUANO CLEARANCE



A PX-ORNIKILL

Contains Chlorhexidine and QAC's (<7.5% w/v)

HAZARD INFORMATION: H314, H412, P260, P264, P273, P280, P301 + P330 + P331, P303 + P361 + P353, P304 + P340, P305 + P351 + P338, P315, P405

Operators cleaning up bird droppings run the risk of inhaling dust containing micro-organisms which may cause ornithosis, psittacosis, histoplasmosis, salmonellosis and other serious diseases. By treating areas where birds are known to have been present with PX®-Ornikill, before, during and after commencement of work, the risk of disease transfer is much reduced. PX®-Ornikill contains a powerful biocide which will kill the bacteria, viruses, fungi, protozoa and rickettsiales (including Chlamydia, E. coli O157, Salmonella, Listeria and Cryptococcus and others) commonly associated with pigeons, starlings, gulls and other pest birds.

Normal dilution 1:50.

Dilution of 1:10 to treat dead birds and nesting materials.

PXORN001L	1 x 1ltr squeeze and pour	
PXORN005L	1 x 5ltr	

B CLEAR POLYTHENE SACKS

To prevent contamination of personnel by spent pesticides and contaminated PPE it is recommended that it is bagged in 300 gauge clear polythene sacks. This grade of bag should be used when transporting pesticide waste to Killgerm's transfer station. These bags can also be used to bag up pigeon guano prior to disposal.

PLASTSACK	300 gauge clear polythene sacks (Pack of 25)
CABLETIE430MM	UV stable Cable ties 430mm x 4.8mm (Pack of 100)

C TYVEK® 600 PLUS COVERALLS TYPE 4, 5 & 6 (FORMERLY TYVEK® CLASSIC PLUS)

The Tyvek® 600 Plus Coverall offers protection against categories 4,5 and 6. The garment design offers ease of movement to the wearer, while the hood and elastic around the hood are designed for tight fit around a full face respirator. The seams are stitched and overtaped, offering equal barrier as fabric.

	WHITE
TYVEK600-M	Medium (36-39.5")
TYVEK600-L	Large (39-42.5")
TYVEK600-XL	Extra large (42-46")
TYVEK600-XXL	Extra, extra large (45.5-49")

D SUNDSTROM FULL-FACEMASK RESPIRATOR

Conforms to EN 136 standard. A silicon wide-vision full-facemask for optimum protection, comfort and vision.

SUNDFULLMASK	Each
SUNDFILP3	P3 Filter



Killgerm®

You know when
you're in safe hands!

www.killgerm.com

PX

RANGE

Killgerm's exclusive
range of cleaning and
hygiene products

Manufactured by experts for use by professionals

SUMMARY OF PRODUCTS AND ACTIVE INGREDIENTS

For general disinfecting and deodorising the following products are available. These products would be suitable for use in hospitals, institutions, industrial premises, catering establishments, food handling and processing plants, abattoirs, etc., chosen according to the indications given in the table below. Product efficacy can be gauged for a particular situation by reference to the individual product label and technical data sheet. Specialist advice is available to ensure that the best product for the job is selected.

PRODUCT PROPERTIES AND AREAS OF USE DATA

PRODUCT NAME	DISINFECTANT	DEODORANT	ACTIVE INGREDIENT	USES /NOTES
PX-ORNIKILL	✓	✗	QAC + Chlorhexidine	Use in situations where pest birds have been present. 1
ANTI-STATIC	✗	✗	Surfactants	Anti-static formulation. 2
SOL-ODAMASK	✗	✓	Deodorants	Industrial deodorant. 3

Notes

1. Product has a citrus odour. Not for direct use on food preparation surfaces or in food preparation areas. Ready to use ULV presentation is available.
2. Anti-static formulation for dilution with water and spray application.
3. Industrial deodorant for dilution with water and spray application.
4. Concentrated odour countering formulation for diluting in water and spray application or via ULV presentation dispenser. Wild mint odour.
5. Non-caustic, non-corrosive, non-toxic, biologically enhanced formulation, that can be used neat or diluted for spray application.



A KILLGERM NILAQUA INSTANT HAND SANITISER

Killgerm Hand Sanitiser (Nil aqua) is an alcohol-free, quick drying hand sanitiser that offers post application protection for up to 6 hours. Based on two active ingredients, Didecyl Dimethyl Ammonium Chloride and Quaternary Ammonium Compounds, it Kills up to 99.9999% of germs, including Coronavirus, MRSA, C-diff, Norovirus and more. Killgerm Hand Sanitiser (Nil aqua) is non-skin drying and non-skin irritating. EN1500 approved product (Hygienic Hand Rub test - pass).

NILAQUA7X100 7 x 100ml

B PX-ORNIKILL

Contains Chlorhexidine and QAC's (<7.5% w/v)

HAZARD INFORMATION: H314, H412, P260, P264, P273, P280, P301 + P330 + P331, P303 + P361 + P353, P304 + P340, P305 + P351 + P338, P315, P405

Operators cleaning up bird droppings run the risk of inhaling dust containing micro-organisms which may cause *ornithosis*, *psittacosis*, *histoplasmosis*, *salmonellosis* and other serious diseases. By treating areas where birds are known to have been present with PX®-Ornikill, before, during and after commencement of work, the risk of disease transfer is much reduced. PX®-Ornikill contains a powerful biocide which will kill the bacteria, viruses, fungi, protozoa and rickettsiales (including *Chlamydia*, *E. coli* O157, *Salmonella*, *Listeria*, *Cryptococcus* and others) commonly associated with pigeons, starlings, gulls and other pest birds. Normal dilution 1:50. Dilution of 1:10 to treat dead birds and nesting materials.

PXORN001L	1 x 1 litre squeeze and pour	
PXORN005L	1 x 5 litres	



C SOL-ODAMASK

HAZARD INFORMATION: H315, H411, P210, P233, P243, P261, P264, P273, P280, P302 + P352, P333 + P313, P362, P391, P403, P501

Sol-Odamask is a highly concentrated formulation of essential oils, odour absorbents and emulsifiers. This deodorant product is non-corrosive even at high levels of concentration. It can be used at a dilution of between 1:150 and 1:1000 depending on the intensity of the malodour.

SOLOH001L	1 x 1 litres		
SOLOH005L	1 x 5 litres		
SOLOH200L	1 x 200 litres		

D NILAQUA DISPENSER

Nilaqua Dispensers are ideal for all washrooms with high traffic and come with a refillable cartridge that provides less waste environmentally and cost benefits too. Holds up to 1000ml and made from durable ABS plastic. Refills are available in 5 litre bottles or 800ml pouches.

- "Slim Look" design
- Glossy shiny surface
- Recessed window for viewing soap levels
- Permanent install with screw sets or adhesive for effortless installation

NILAQUADISP	Each	
--------------------	------	--

E NILAQUA HAND SANITISER REFILL

Nilaqua hand sanitisers are alcohol-free, killing germs whilst being kind and gentle to the skin.

- Alcohol Free Sanitiser
 - EN1500 approved
 - Non-irritating, drying and toxic
 - Tested Food and Skin Safe
 - Won't remove nail polish
 - Dries quickly, fragrance free
 - Doesn't leave an oily residue
- Nilaqua Sanitiser kills germs fast, yet is gentle to the skin and won't sting cuts or dry the skin.

NILAQUA800ML	1 x 800ml pouch	
NILAQUA005L	1 x 5 Litres	



NEW DATES FOR 2023

NORTHERN

8th February - Hull
15th February - Durham
27th April - Doncaster
13th September - Liverpool
4th October - Penrith

MIDLANDS

25th January - Derby
1st February - Stoke-on-Trent
24th May - Birmingham
26th September - Northampton
18th October - Bury St Edmonds

SOUTHERN

29th March - East London
9th May - Hertfordshire
22nd November - West London
13th December - South London
14th December - Newbury

SCOTLAND

4th October - West Lothian

WALES

13th September - Cardiff

NORTHERN IRELAND

28th March - Belfast

 Killgerm®
Breakfast
MEETINGS

Book online at
www.killgerm.com
OR CALL **01924 268516**

Dates and venues are subject to change in accordance with the government guidelines. Please check our website for updates.

Use products safely. Always read the label and product information before use.

An essential tool for every pest controller

www.killgerm.com

Easy to use, quick to navigate and full of information.



Responsive

It is a responsive website, which means that the website responds directly to the device that it is being viewed on. The result is an optimal viewing experience. Any device, same great website.



Technical and Training

The technical section of our website offers a full calendar of our training dates with the ability to reserve your place with just the click of a button. It has a frequently asked questions page and can guide you to all the information you need regarding insect identification, inspections and audits.



Technical Advice

Our Technical Support Advisor, Louise Loben is on the end of our dedicated technical hotline to answer your daily queries.



Online Catalogue

Our online catalogue offers fully secured login and payment for online purchases to give you full confidence in using our website to purchase products. It is easy to navigate and has a powerful search engine to help find what you need.



Downloads

The free downloads section which includes work-studies, environmental assessments, safety data sheets, labels and instructions for use, provides our customers with a vast library of information that is easily accessible and quick to call on.



Events, News & Resources

All the details of our workshops and free breakfast meetings with the ability to book your place online can be found here. With an up-to-date news section, a recruitment page and the details of Plus Points and our Subsidised Waste Disposal Scheme it is full of vital information and resources.



Plus Points

The NO1 industry reward scheme. A difference to your shopping that makes a difference to your business. The Plus Points scheme is FREE to join.



Waste Disposal Scheme

Killgerm has been operating the scheme to aid customers with the safe and environmentally sound disposal of their work-generated waste for over 20 years now, and many professional pest controllers regularly take advantage of the service.



The Killgerm Support & Ordering Apps!

Now you can order our great products and get all the latest, trusted pest control information, wherever you're connected! Download both apps on the App Store or get them on Google Play.

Killgerm Technical Support

Killgerm's highly qualified technical department is the largest of any distributor in Europe. We are committed to supporting you every step of the way - from independent and unbiased advice on product selection to helping to solve technical problems. You only have to pick up the phone to receive technical help. Killgerm is dedicated to bringing you the largest range of innovative products first, providing you with the tools you need that make a difference. Developing, reviewing and testing products to ensure that they are practical, effective and low risk for their intended purposes. Our product development team have contacts in pest control all over the world, meaning we are one of the first to hear about new products.



DR MATTHEW DAVIES
Head of Technical Department
BSc (Hons), PhD, MRSB, MRSPh



ROBIN MOSS
Senior Technical Manager (North)
H.N.D. Agric, CBiol, FSB, FRSPH



MELVIN KNAPP
Technical Manager (South)
FRSPH, ACE-I



AVRIL TURNER
Technical Manager (Midlands)
BSc (Hons), FRSPH, Tech IOSH



ALASTAIR FERNIE
Bird Control Specialist
AMRSPH



JONATHAN BINGE
Entomologist
BSc(Hons), FRES



LISA WALES
Training Co-ordinator



PHILIP DALGLIESH
Company Chemist
BSc, CChem, MRSC, MBIRA, CSI, MCIWM, CENV



STEPHEN LEAHY
Regulatory Affairs Chemist
M.Chem



LISA JAGGAR
Technical Administrator

INSECT IDENTIFICATION

Killgerm Insect Identification Service provides details of the biology of the pest and helpful advice on any necessary control measures.

Killgerm endeavours to provide a full ID report within 14 working days because we know how important it is to your business to receive this information quickly. Samples can be sent to: Killgerm Identification, Wakefield Road, Ossett, West Yorkshire, WF5 9AJ.

Please ensure that your address and contact telephone number are clearly visible on the padded envelope (or other suitable packaging) when sending specimens for identification. Please submit specimens in crushproof, non-metallic containers with securely sealed lids and ensure specimen is dead before posting. Failure to carry out these simple precautions may result in a delay before the package is opened and dealt with.

The service is free of charge to existing Killgerm customers (subject to account status). The service is charged at £50 + VAT to non-customers.

The identification of spiders is not within our area of expertise. Please contact the Natural History Museum (www.nhm.ac.uk) for spider identifications. Please note that large samples such as vacuum bag contents will be returned unchecked. Small samples of vacuum bag contents or contaminated produce can be inspected and must not exceed the 30ml volume of a screw-top sample tube.

Occasional catch-tray / glue board analysis of flying insects from electronic fly killers is chargeable at £75+VAT per tray / board or other large sample of insects e.g. more than the contents of a 30ml sample tube.

Please email the Technical Team below for further details or visit <https://www.killgerm.com/technical/insect-identification/> to download the Insect ID form.

For further information regarding this service contact identification@killgerm.com



MARK WARD
Product Development Specialist

KILLGERM PRODUCT DEVELOPMENT

The product development department source innovative and creative solutions for the professional pest control industry. They develop new products for Killgerm, ensuring that they are practical, effective and safe for their intended purposes. In addition, the product development department undertakes product testing and evaluation to ensure that the selection of products offered by Killgerm meets customer's requirements.



LOUISE LOBEN
Technical Support Advisor
MRSPh, MBPR

TECHNICAL SUPPORT ADVISOR

Louise Loben, our Technical Support Advisor, is on the end of our dedicated technical hotline to answer your daily enquiries.

NORTHERN COURSES 2023

Date	Venue	Cost plus VAT
BASIC PRINCIPLES OF PEST CONTROL		
Open Awards Level 2 Award in the Principles of Rodent Control		
10th Jan 2023	Ossett	* £125/£155
14th Feb 2023	Ossett	* £125/£155
7th March 2023	Ossett	* £125/£155
4th April 2023	Ossett	* £125/£155
9th May 2023	Ossett	* £125/£155
6th June 2023	Ossett	* £125/£155
18th July 2023	Ossett	* £125/£155
22nd August 2023	Ossett	* £125/£155
5th Sept 2023	Ossett	* £125/£155
3rd Oct 2023	Ossett	* £125/£155
7th Nov 2023	Ossett	* £125/£155
5th Dec 2023	Ossett	* £125/£155
Killgerm Principles of Insect Control		
11th & 12th Jan 2023	Ossett	* £180/£210
5th & 6th April 2023	Ossett	* £180/£210
6th & 7th Sept 2023	Ossett	* £180/£210
8th & 9th Nov 2023	Ossett	* £180/£210
REFRESHER COURSES		
Pest Control Refresher/Update		
2nd March 2023	Kendal	* £55/£155
4th May 2023	Ossett	* £55/£155
5th Oct 2023	Ossett	* £55/£155
SPECIALIST COURSES		
Safe use of Air Weapons for Bird Control		
14th March 2023	Holmes Chapel	£190 Inc lunch
2nd May 2023	Doncaster	£190 Inc lunch
23rd May 2023	Holmes Chapel	£190 Inc lunch
18th July 2023	Holmes Chapel	£190 Inc lunch
17th Oct 2023	Doncaster	£190 Inc lunch
Bird Control		
11th & 12th September 2023	Holmes Chapel	£270 Inc lunch
Bird Free		
24th May 2023	Ossett	£120 Inc lunch
Insect Identification		
18th May 2023	Ossett	£190 Inc lunch
Drainage Investigations & Rat Control		
29th March 2023	Ossett	£190 Inc lunch
22nd June 2023	Ossett	£190 Inc lunch
12th Oct 2023	Ossett	£190 Inc lunch
Flying Insect Management		
23rd March 2023	Ossett	£155 Inc lunch

Date	Venue	Cost plus VAT
INSECT WORKSHOPS		
Insect Workshop 1 - Bedbugs & Fleas		
16th May 2023	Ossett	£155 Inc lunch
Insect Workshop 2 - Ants, Bees and Wasps		
21st March 2023	Ossett	£155 Inc lunch
PRACTICAL COURSES		
Trapping Techniques		
30th March 2023	Killamarsh	£155 Inc lunch
19th Oct 2023	Killamarsh	£155 Inc lunch
16th Nov 2023	Killamarsh	£155 Inc lunch

Course Charges
* Reduced rate applies to existing Killgerm customers who have reached a set minimum annual spend limit.

ROYAL SOCIETY FOR PUBLIC HEALTH AND BRITISH PEST CONTROL ASSOCIATION - LEVEL 2 AWARD IN PEST MANAGEMENT	
FEE - £900 + VAT per person (includes Killgerm manual, RSPH Exam, lunch & refreshments)	
Venue: Ossett	
Unit 3	Monday 23rd & Tuesday 24th January 2023
Unit 1	Monday 30th & Tuesday 31st January 2023
Unit 2	Monday 6th & Tuesday 7th February 2023
Examination	Wednesday 8th February 2023
Venue: Ossett	
Units 1 to 3	Tuesday 13th to Tuesday 20th June 2023
Examination	Wednesday 21st June 2023
Venue: Ossett	
Unit 3	Monday 9th & Tuesday 10th October 2023
Unit 1	Monday 16th & Tuesday 17th October 2023
Unit 2	Monday 23rd & Tuesday 24th October 2023
Examination	Wednesday 25th October 2023
ROYAL SOCIETY FOR PUBLIC HEALTH LEVEL 3 AWARD IN PEST MANAGEMENT. FEE - £800 + VAT per person (includes RSPH Exam, lunch & refreshments)	
Venue: TBC	
Training and Information day	
Core Unit examination	

SOUTHERN COURSES 2023

For further information on any of these training courses or to book your place, call Lisa Wales on 01924 268445. Alternatively email training@killgerm.com or book online at www.killgerm.com.

Date	Venue	Cost plus VAT
EAST ANGLIA		
BASIC PRINCIPLES OF PEST CONTROL		
Open Awards Level 2 Award in the Principles of Rodent Control		
14th March 2023	Norwich	* £125/£155
12th Sept 2023	Norwich	* £125/£155
Killgerm Principles of Insect Control		
15th & 16th March 2023	Norwich	* £180/£210
13th & 14th Sept 2023	Norwich	* £180/£210
REFRESHER COURSES		
Pest Control Refresher/Update		
4th April 2023	Norwich	* £55/£155
INSECT WORKSHOPS		
Insect Workshop 2 - Ants, Bees and Wasps		
5th April 2023	Norwich	£155 Inc lunch

Date	Venue	Cost plus VAT
SURREY		
BASIC PRINCIPLES OF PEST CONTROL		
Open Awards Level 2 Award in the Principles of Rodent Control		
7th March 2023	Lingfield	* £125/£155
18th July 2023	Lingfield	* £125/£155
19th Sept 2023	Lingfield	* £125/£155
Killgerm Principles of Insect Control		
8th & 9th March 2023	Lingfield	* £180/£210
19th & 20th July 2023	Lingfield	* £180/£210
20th & 21st Sept 2023	Lingfield	* £180/£210
SPECIALIST COURSES		
Safe use of Air Weapons for Bird Control		
18th April 2023	Reading	£190 Inc lunch
9th May 2023	Bisley	£190 Inc lunch
27th July 2023	Reading	£190 Inc lunch
19th Sept 2023	Reading	£190 Inc lunch
24th Oct 2023	Bisley	£190 Inc lunch
Bird Control		
25th & 26th July 2023	Reading	£270 Inc lunch
Bird Free		
21st Sept 2023	Reigate	£120 Inc lunch
Drainage Investigations & Rat Control		
8th June 2023	Reigate	£190 Inc lunch

Date	Venue	Cost plus VAT
BERKSHIRE & HAMPSHIRE		
BASIC PRINCIPLES OF PEST CONTROL		
Open Awards Level 2 Award in the Principles of Rodent Control		
28th March 2023	Newbury	* £125/£155
14th June 2023	Newbury	* £125/£155
30th May 2023	Newbury	* £125/£155
11th Oct 2023	Newbury	* £125/£155
Killgerm Principles of Insect Control		
29th & 30th March 2023	Newbury	* £180/£210
REFRESHER COURSES		

Date	Venue	Cost plus VAT
Pest Control Refresher/Update		
22nd June 2023	Newbury	* £55/£155
27th Sept 2023	Newbury	* £55/£155
SPECIALIST COURSES		
Insect Identification		
28th Sept 2023	Newbury	£190 Inc lunch
Flying Insect Management		
18th May 2023	Newbury	£155 Inc lunch
Drainage Investigations & Rat Control		
25th May 2023	Newbury	£190 Inc lunch
21st Sept 2023	Newbury	£190 Inc lunch
INSECT WORKSHOPS		
Insect Workshop 1 - Bedbugs & Fleas		
4th May 2023	Newbury	£155 Inc lunch
12th Oct 2023	Newbury	£155 Inc lunch
Insect Workshop 2 - Ants, Bees & Wasps		
3rd May 2023	Newbury	£155 Inc lunch
PRACTICAL COURSES		
Trapping Techniques		
6th September 2023	Hampshire	£155 Inc lunch

Date	Venue	Cost plus VAT
BRISTOL		
BASIC PRINCIPLES OF PEST CONTROL		
Open Awards Level 2 Award in the Principles of Rodent Control		
31st Jan 2023	Bristol	* £125/£155
25th April 2023	Bristol	* £125/£155
28th Nov 2023	Bristol	* £125/£155
Killgerm Principles of Insect Control		
1st & 2nd Feb 2023	Bristol	* £180/£210
29th & 30th Nov 2023	Bristol	* £180/£210
REFRESHER COURSES		
Pest Control Refresher/Update		
26th April 2023	Bristol	* £55/£155
24th Oct 2023	Bristol	* £55/£155
SPECIALIST COURSES		
Safe use of Air Weapons for Bird Control		
26th Sept 2023	Portishead, Bristol	£190 Inc lunch
Bird Control		
27th & 28th Sept 2023	Portishead, Bristol	£270 Inc lunch
Drainage Investigations & Rat Control		
9th March 2023	Bristol	£190 Inc lunch
INSECT WORKSHOPS		
Insect Workshop 2 - Ants, Bees & Wasps		
24th May 2023	Bristol	£155 Inc lunch

Course Charges

* Reduced rate applies to existing Killgerm customers who have reached a set minimum annual spend limit.

SCOTTISH COURSES 2023

Date	Venue	Cost plus VAT
MIDLANDS		
BASIC PRINCIPLES OF PEST CONTROL		
Open Awards Level 2 Award in the Principles of Rodent Control		
14th March 2023	Burton on Trent	* £125/£155
21st Nov 2023	Burton on Trent	* £125/£155
Killgerm Principles of Insect Control		
15th & 16th March 2023	Burton on Trent	* £180/£210
22nd & 23rd Nov 2023	Burton on Trent	* £180/£210
REFRESHER COURSES		
Pest Control Refresher/Update		
20th Sept 2023	Burton on Trent	* £55/£155
SPECIALIST COURSES		
Safe use of Air Weapons for Bird Control		
3rd May 2023	Kibworth	£190 Inc lunch
11th July 2023	Kibworth	£190 Inc lunch
6th Sept 2023	Kibworth	£190 Inc lunch
Bird Control		
12th & 13th July 2023	Kibworth	£270 Inc lunch
Flying Insect Management		
26th April 2023	Burton on Trent	£155 Inc lunch
Drainage Investigations & Rat Control		
16th Feb 2023	Burton on Trent	£190 Inc lunch
10th August 2023	Burton on Trent	£190 Inc lunch
INSECT WORKSHOPS		
Insect Workshop 1 - Bedbugs & Fleas		
28th Sept 2023	Burton on Trent	£155 Inc lunch
Insect Workshop 2 - Ants, Bees & Wasps		
27th April 2023	Burton on Trent	£155 Inc lunch

**ROYAL SOCIETY FOR PUBLIC HEALTH AND BRITISH PEST CONTROL ASSOCIATION
LEVEL 2 AWARD IN PEST MANAGEMENT**
FEE - £900 + VAT per person (includes Killgerm manual, RSPH Exam, lunch & refreshments)

Newbury	
Unit 3	Monday 13th & Tuesday 14th February 2023
Unit 1	Monday 20th & Tuesday 21st February 2023
Unit 2	Monday 27th & Tuesday 28th February 2023
Examination	Wednesday 1st March 2023
Reigate	
Unit 3	Monday 30th & Tuesday 31st October 2023
Unit 1	Monday 6th & Tuesday 7th November 2023
Unit 2	Monday 13th & Tuesday 14th November 2023
Examination	Wednesday 15th November 2023

ROYAL SOCIETY FOR PUBLIC HEALTH LEVEL 3 AWARD IN PEST MANAGEMENT.
FEE - £800 + VAT per person (includes RSPH Exam, lunch & refreshments)

Venue: TBC
Training and Information day
Core Unit examination

Date	Venue	Cost plus VAT
BASIC PRINCIPLES OF PEST CONTROL		
Open Awards Level 2 Award in the Principles of Rodent Control		
21st March 2023	Livingston	* £125/£155
16th May 2023	Livingston	* £125/£155
21st Nov 2023	Huntingtower Hotel, Perth	* £125/£155
Killgerm Principles of Insect Control		
17th & 18th May 2023	Livingston	* £180/£210
22nd & 23rd Nov 2023	Perth	* £180/£210
REFRESHER COURSES		
Pest Control Refresher/Update		
20th April 2023	Livingston	* £55/£155
7th Sept 2023	Huntingtower Hotel, Perth	* £55/£155
SPECIALIST COURSES		
Safe use of Air Weapons for Bird Control		
3rd Oct 2023	Cluny Clays Leisure Centre, Cluny by Kirkcaldy	£190 Inc lunch
Bird Control		
4th & 5th Oct 2023	Cluny Clays Leisure Centre, Cluny by Kirkcaldy	£270 Inc lunch
Insect Identification		
12th July 2023	Livingston	£190 Inc lunch
Flying Insect Management		
25th May 2023	Livingston	£155 Inc lunch
Drainage Investigations & Rat Control		
20th July 2023	Livingston	£190 Inc lunch
INSECT WORKSHOPS		
Insect Workshop 1 - Bedbugs & Fleas		
10th May 2023	Livingston	£155 Inc lunch

Course Charges
* Reduced rate applies to existing Killgerm customers who have reached a set minimum annual spend limit.

**ROYAL SOCIETY FOR PUBLIC HEALTH AND BRITISH PEST CONTROL ASSOCIATION
LEVEL 2 AWARD IN PEST MANAGEMENT**
FEE - £900 + VAT per person (includes Killgerm manual, RSPH Exam, lunch & refreshments)

Livingston	
Unit 3	Tuesday 12th & Wednesday 13th September 2023
Unit 1	Tuesday 19th & Wednesday 20th September 2023
Unit 2	Tuesday 26th & Wednesday 27th September 2023
Examination	Thursday 28th September 2023



The environment

All companies should be prepared to protect the environment so that those who follow us can enjoy a safe environment where they work, live and play.

Killgerm Group takes a very serious view of its responsibilities to the environment. We operate an industry supported waste disposal scheme whereby redundant pesticides and used packaging are disposed of at a subsidised rate.

Killgerm is registered under all relevant industry schemes, such as the British Agrochemical Supply Industry Scheme - a voluntary scheme whereby warehouses are inspected to ensure that they meet the highest standards.

We are a major supporter of the UK Chartered Institute of Environmental Health, which is the professional body for environmental health officers in England, Wales and Northern Ireland. We contribute regularly to the work of the CIEH's National Pest Advisory Panel.

Killgerm also received the Silver EcoVadis Medal for scoring higher than 56/100. This result places us among the top 25 percent of companies assessed by EcoVadis. This is something we will continuously work hard to focus on in the future.

Local Communities

Helping others in the community who need assistance is the duty of every responsible company. Staff members are regular participants in fund-raising events, and Killgerm Group supports these wherever possible.

Killgerm Group is particularly keen to assist charities and these include Water for Kids, who with the industry has helped raise £50,000, which has enabled over 30,000 people to gain clean water.

The bait boxes we have in our product range are made from 100% recyclable plastic and have come from the interior side boards of used cars.

We also sponsor a Flo Hive at the Manchester City Council, which allows them to collect honeybee swarms and relocate them.

Killgerm's corporate responsibility policy

Companies you do business with
should reflect your values

The Industry

Companies should be prepared to put back into the industry some of the benefits which they have received. Killgerm Group has encouraged staff to take a full part in professional and trade bodies, providing presidents, directors and committee members to a wide range of pest control industry bodies.

By supporting and funding university research projects, we have added to the scientific knowledge in the pest management industry. By providing speakers for seminars throughout the world and supporting international conferences such as ICUP, we have assisted in the dissemination of information on a wide range of subjects.

Staff

The most important asset in any company is its staff and Killgerm Group believes in assisting staff to obtain higher qualifications. We have provided long-term employment to staff under a number of Government-backed schemes.

Killgerm Group is committed to an active Equal Opportunities Policy from recruitment to selection, through training and development, performance review and promotion through to retirement.

Modern Slavery Act

Killgerm Group Limited recognises that modern slavery and human trafficking are significant global issues presenting a challenge for businesses worldwide. We are committed to improving our practices to combat slavery and human trafficking. We have a zero-tolerance approach to modern slavery and are committed to acting ethically and with integrity in our business dealings.

PRODUCT RANGE AND DELIVERY

As a distributor of public hygiene products, we pride ourselves on being able to offer the widest range of pest control and related products in Europe. We are not tied to any manufacturer and are therefore the first to be approached for new product and market advice. Not only do we have everything you need under one roof, we can deliver within the shortest possible time. Our modern warehouse and production facilities allows us to hold large stocks of most catalogue items, which can normally be delivered to you the next day. If an order is urgent, please let us know so that we can give it extra priority. We maintain excellent links with our suppliers so that non-stock items can also be delivered rapidly. Even items not in our catalogue can often be sourced for you.

PAYMENT



Ordering and payment are easy. Orders may be placed by post, email, telephone, via the website or in person. We also offer a range of payment options:

- **Credit/debit card** - we accept all major credit and debit cards.
- **Cash** - if you collect goods in person from our warehouse, we will accept cash.
- **Account** - you may apply for trade credit with payment terms of 30 days from date of invoice by completing a simple application form, which we can send to you upon request. Credit will be granted dependent upon the outcome of trade and bank enquiries. With an account you may pay by cheque, bank transfer or debit card.

STANDARD TERMS AND CONDITIONS FOR THE SALE OF GOODS

STANDARD TERMS AND CONDITIONS FOR THE SALE OF GOODS

1 INTERPRETATION

1.1 In these Conditions, the following definitions and rules of interpretation shall apply:

Business Day: a day (other than a Saturday, Sunday or public holiday) when banks in Dublin are open for business.

Business Day conditions: the terms and conditions set out in this document as amended from time to time in accordance with clauses 17.1 and/or 17.2.

Contract: the contract between the Supplier and the Customer for the sale and purchase of the Goods in accordance with these Conditions.

Controlled Products: includes but is not limited to Goods which are subject to the requirements set out in any of; the Control of Pesticides Regulations 1986 and 1987 (as amended), the Control of Pesticides (Amendment) Regulations 1997, the Plant Protection Products Regulations 2005, or the Poisons Rules.

Customer: the person or firm who purchases the Goods from the Supplier.

Document: includes all instruction or training manuals relating to the Goods and in addition to any document in writing, any drawing, map, plan, diagram, design, picture or other image, tape, disk or other device or record embodying information in any form.

Force Majeure Event: has the meaning given in clause 13.

Goods: those goods which are sold by the Supplier from time to time as set out in the Order.

Incoterms: means the international rules for the interpretation of trade terms of the International Chamber of Commerce as in force as at the date when the Contract is made.

Intellectual Property Rights: all patents, rights to inventions, utility models, copyright and related rights, trademarks, service marks, trade, business and domain names, rights in trade dress or get-up, rights in goodwill or to sue for passing off, unfair competition rights, rights in designs, rights in computer software, database right, topography rights, moral rights, rights in confidential information (including know-how and trade secrets) and any other intellectual property rights, in each case whether registered or unregistered and including all applications for and renewals or extensions of such rights, and all similar or equivalent rights or forms of protection in any part of the world.

Order: the Customer's order for the Goods, as submitted in accordance with clause 3.1.

PPE: the personal protective equipment, which may be required or recommended to use the Goods.

Poisons Rules: incorporating the Poisons Act 1972 and the Poisons (Amendment) Rules 1989.

Supplier: Killgerm Ireland Limited (CRO 453018).

1.2 A person includes a natural person, corporate or unincorporated body (whether or not having separate legal personality).

1.3 A reference to a party includes its personal representatives, successors or permitted assigns.

1.4 A reference to a statute or statutory provision is a reference to such statute or provision as amended or re-enacted. A reference to a statute or statutory provision includes any subordinate legislation made under that statute or statutory provision, as amended or re-enacted.

1.5 Any phrase introduced by the terms including, include, in particular or any similar expression shall be construed as illustrative and shall not limit the sense of the words preceding those terms.

1.6 A reference to writing or written includes faxes and e-mails.

1.7 Unless the context otherwise requires, any term or expression which is defined in or given a particular meaning by the provisions of the Incoterms shall have the same meaning in these Conditions, but if there is any conflict between the provisions of Incoterms and these Conditions, these Conditions shall prevail.

2 BASIS OF CONTRACT

2.1 These Conditions apply to the Contract to the exclusion of any other terms that the Customer seeks to impose or incorporate, or which are implied by trade, custom, practice or course of dealing.

2.2 The Contract constitutes the entire agreement between the parties. The Customer acknowledges that it has not relied on any statement, promise,

representation, assurance or warranty made or given by or on behalf of the Supplier, which is not set out in the Contract. Any samples, drawings, descriptive matter, or advertising issued by the Supplier and any descriptions or illustrations contained in the Supplier's catalogues, brochures or on the Supplier's web site are issued or published for the sole purpose of giving an approximate idea of the Goods described in them. They shall not form part of the Contract or any other contract between the Supplier and the Customer for the sale of the Goods or have any contractual force.

2.3 Nothing in these Conditions will affect the statutory rights of the Customer if he "deals as a consumer" pursuant to section 12 of the Unfair Contract Terms Act 1977 (as amended from time to time).

2.4 The PPE illustrated in the Supplier's catalogue or on the Supplier's web site are recommendations made by the Supplier to the Customer when the Customer is using Goods for their intended purpose. The Supplier's suggested PPE is for illustration purposes only and should not be relied upon by the Customer.

2.5 For full requirements on the PPE for use with the Goods, the Customer should refer to the product label and safety data sheet relating to the Goods and should take into account the Customer's own circumstances or Customer's intended use for the Goods. The Supplier's PPE illustrations should in no way replace any part of a Customer's control of substances hazardous to health assessment and the Supplier will not be responsible for any loss or damage arising from the Customer's reliance upon, and sole use of, the PPE's illustrated in the Supplier's catalogue and on the Supplier's website.

2.6 A quotation for the Goods given by the Supplier is subject to these Conditions and shall not constitute an offer. A quotation can be given by the Supplier orally or in writing but shall only be valid for the period of time from the date it is issued, as confirmed by the Supplier (if oral) or set out on such quotation (if in writing). If no such period of time is confirmed or set out (as applicable) a quotation shall only be valid for the period of 2 Business Days from the date it was given to the Customer by the Supplier.

2.7 If the Customer places an Order through the Supplier's website, the Customer warrants that it is legally capable of entering into binding contracts and (if an individual) the Customer is at least 18 years old.

3 ORDERS

3.1 When the Customer wishes to place an Order, it shall:

3.1.1 send its written purchase order to the Supplier; or

3.1.2 submit an Order either orally, or in writing to the Supplier; or

3.1.3 accept either orally, or in writing the Supplier's quotation; or

3.1.4 place an Order via an email generated and sent to the Supplier using the Supplier's website.

3.2 The Order constitutes an offer by the Customer to purchase the Goods in accordance with these Conditions. The Customer is responsible for ensuring that the terms of the Order are complete and accurate.

3.3 Each Order shall be deemed to be a separate offer by the Customer to buy the Goods on the terms of these Conditions, which the Supplier shall be free to accept or decline at its absolute discretion. Prior to acceptance of the Order, the Supplier may, at its absolute discretion, request evidence in writing of the Customers' (or its contractors, agents or employees) qualifications to handle and use Controlled Products.

3.4 Subject to clause 4.1, no Order shall be deemed to be accepted by the Supplier until it issues a written or email acceptance of the Order, or (in circumstances where no written or email acceptance is provided) completion of despatch of the Goods by the Supplier for delivery to the Customer, or the Supplier notifies the Customer that the Goods are ready for collection (as the case may be).

3.5 The Contract will only relate to those Goods set out in the Order and which the Supplier has accepted in accordance with clause 3.4.

3.6 Subject to clause 3.7, the Customer may at any time prior to despatch of the Goods amend or cancel an Order by written notice to the Supplier. If the Customer amends or cancels an Order, its liability to the Supplier shall be limited to payment to the Supplier of all costs reasonably incurred by the Supplier in fulfilling the Order up until the date of amendment or cancellation.

3.7 The Customer cannot amend or cancel an Order or a Contract in accordance with 3.6 without the written consent of the Supplier if; the packaging or labelling on the Goods is to the Customer's own specification or, the

Customer is in breach of any of the provisions set out in clause 4. Such consent is at the Supplier's sole discretion after acceptance of an Order. If the Supplier consents to such amendments or cancellation of an Order or Contract, the Customer's liability to the Supplier shall be limited to the payment to the Supplier of all costs reasonably incurred by the Supplier in fulfilling the Order and/or Contract up to the date of amendment or cancellation.

3.8 The Supplier may cancel an Order at any time before the Goods are delivered or supplied by giving written notice to the Customer. On giving such written notice the Supplier shall promptly repay to the Customer any sum paid in respect of the price of the Goods.

4 SPECIAL CONDITIONS

4.1 Poisons

4.1.1 Any Goods marked (P) including Degesch Fumigation Tablets and Plates, Phostoxin and Talunex Tablets are subject to the Poisons Rules and can only be supplied to authorised Customers against an Order signed by an authorised representative of the Customer and stating the purpose for which the Goods are to be used.

4.1.2 Notwithstanding the requirements specified in clause 4.1.1, the Goods known as Degesch Fumigation Tablets and Plates require the Customer to have the relevant approved qualification and therefore an Order for such Goods will not be accepted by the Supplier unless the Customer provides evidence satisfactory to the Supplier that the Customer is qualified and competent.

4.2 Pesticides – Risk Reduction

Before Customers use Goods known as biocides they should always read the label and product information relating to the Goods before use.

4.3 Electrical Goods and Spares – Risk Reduction

4.4.1 Some of the Goods (including those detailed below) fall within the scope of regulations and other legislation which apply from time to time to the carriage of dangerous goods and use of transportable pressure equipment:

4.4.1.1 Degesch Fumigation Tablets and Plates;

4.4.1.2 Phostoxin;

and

4.4.1.3 Talunex.

4.4.2 The Goods referred to in clause 4.4.1 will be packed in UN packaging, with relevant marking and labelling requirements and supported with dangerous goods notes.

4.4.3 The Supplier's usual carriers will not carry the Goods referred to in clause 4.4.1

4.4.4 and the Supplier will use a specialist carrier that will result in the cost of delivery of the Goods being higher and the Goods taking longer than the Customer

4.5 Approval Categories

4.5.1 Goods classified as pesticides may only be used for the purposes for which they have been approved. The label attached to those Goods and any Document relating to the Goods set out the application, application method and application rate.

4.5.2 The application section of conditions of approval indicate the types of user and areas of use. These are "amateur" or "professional". These classifications apply to the Goods classified as insecticides, rodenticides, biocides and wood preservatives.

4.6 Export Terms

4.6.1 Where the Goods are supplied for export from the United Kingdom, the provisions of this clause 4.6 shall (subject to any special terms agreed in writing between the Customers and the Supplier) apply notwithstanding any other provision of these Conditions.

4.6.2 The Customer shall be responsible for arranging for testing and inspection of the Goods at the Supplier's premises before shipment. The Supplier shall have no liability for any claim in respect of any defect in the Goods which would be apparent on inspection and which is made after shipment, or in respect of any damage during transit.

- 4.6.3 The Customer will be responsible for the payment of any import duties and taxes which are levied when the Goods reach the specified destination and for contacting its own local customs office for details about such duties and taxes as these may vary from country to country. The Supplier has no control over these charges and cannot predict their amount and advises the Customer to contact its local customs office for further information before placing an Order.
- 4.6.4 The Customer shall be responsible for complying with any legislation or regulations governing the importation of Goods into the country of destination.
- 5. DELIVERY OF GOODS**
- 5.1 The Supplier shall ensure that each delivery of the Goods is accompanied by a delivery note which shows the date of the Order, all relevant Customer and Supplier reference numbers, the type and quantity of the Goods (including the code number of the Goods, where applicable) and, if the Order is being delivered by instalments, the outstanding balance of Goods remaining to be delivered.
- 5.2 When the Customer places an Order it shall provide the Supplier with the delivery location for the Goods and:
- 5.2.1 if the Supplier is to deliver or procure delivery of the Goods, the Supplier shall deliver the Goods to the location set out in the Order or such other location as the parties may agree at any time before the Goods are dispatched for delivery; or
- 5.2.2 if the Customer is to collect the Goods, the Customer shall collect the goods from the Supplier's premises at Killgerm Ireland, Unit B2 Centre Point, Rosemount Business Park, Dublin 11, D11 HPS2, or such other location as may be advised by the Supplier at any time prior to delivery.
- 5.3 Delivery of the Goods shall be completed, in the case of the Supplier's delivery of the Goods, on the Goods' arrival at the location referred to in clause 5.2.1, or in the case of the Customer's collection of the Goods on the completion of loading of the Goods at the location referred to in clause 5.2.2.
- 5.4 Any dates quoted for delivery are approximate only, and the time of delivery is not of the essence. The Supplier shall not be liable for any delay in delivery of the Goods, including as a result of a Force Majeure Event as further provided for in clause 13 or the Customer's failure to provide the Supplier with adequate delivery instructions or any other instructions that are relevant to the supply of the Goods.
- 5.5 As the Supplier's carrier will not accept liability for damage, or non-delivery of all or part of the Goods unless the carrier is notified of any damage or non-delivery at the time of delivery, damage or non-delivery of any Goods must be notified to the Supplier's carrier in writing on delivery and a Customer's claim for such damage to, or partial non-delivery or non-delivery of all of the Goods, must be submitted orally, or in writing to the Supplier within 3 Business Days of delivery of the Goods.
- 5.6 If the Goods are damaged in transit or the Supplier fails to deliver all or part of the Goods, its liability shall be limited to (at the Supplier's sole discretion) replacement of the Goods damaged or which the Supplier failed to deliver, or a refund of the price paid by the Customer for the damaged or non-delivered Goods. The Supplier shall have no liability for any failure to deliver the Goods to the extent that such failure is caused by a Force Majeure Event or the Customer's failure to provide the Supplier with adequate delivery instructions or any other instructions that are relevant to the supply of the Goods.
- 5.7 If the Customer fails to notify the Supplier within the period of time referred to in clause 5.5, fails to accept delivery of the Goods from the Supplier or the Supplier's carrier, or to collect the Goods (if applicable) within 3 Business Days of the Supplier's delivery of the Goods shall be deemed to have been completed at 9.00 am on the third Business Day following the day on which the Supplier notified the Customer that the Goods were ready; and
- 5.7.1 the Supplier shall store the Goods until delivery takes place, and charge the Customer for all related costs and expenses (including insurance).
- 5.8 If the Customer fails to accept delivery of the Goods from the Supplier or the Supplier's carrier, or if 3 Business Days after the Supplier notified the Customer that the Goods were ready for delivery the Customer has not taken delivery of them (as applicable), the Supplier may resell or otherwise dispose of part or all of the Goods and, after deducting reasonable storage and selling costs, account to the Customer for any excess over the price of the Goods or charge the Customer for any shortfall below the price of the Goods.
- 5.9 The Customer shall not be entitled to reject the Goods if the Supplier delivers up to and including 5% more or less than the quantity of Goods ordered, but a pro rata increase or reduction shall be made to the Order invoice on receipt of notice from the Customer that the wrong quantity of Goods was delivered.
- 5.10 The Supplier may deliver the Goods by instalments, which shall be invoiced and paid for separately. Each instalment shall constitute a separate Contract. Any delay in delivery or defect in an instalment shall not entitle the Customer to cancel any other instalment.
- 6. QUALITY**
- 6.1 As the Supplier is not the manufacturer of the Goods, the Supplier will use all reasonable endeavours to transfer to the Customer the benefit of any warranty or guarantee given to the Supplier by the manufacturer of the Goods. Details of any warranty or guarantee of the Goods are set out on the packaging or label relating to the Goods. Subject to clause 6.3, if:
- 6.1.1 the Customer gives notice in writing to the Supplier during any warranty or guarantee period relating to the Goods within a reasonable time of discovery that some or all of the Goods do not comply with such warranty or guarantee; and
- 6.1.2 the Supplier is given a reasonable opportunity of examining such Goods; and
- 6.1.3 the Customer (if asked to do so by the Supplier) returns such Goods to the Supplier's place of business at the Customer's cost, the Supplier shall, at its option, repair or replace the defective Goods (as applicable to the Goods), or refund the price of the defective Goods in full.
- 6.2 The Supplier shall not be liable for the Goods' failure to comply with any warranty or guarantee relating to the Goods if:
- 6.2.1 the Customer makes any further use of such Goods after giving notice in accordance with clause 6.1; or
- 6.2.2 the defect arises because the Customer failed to follow the Supplier's oral or written instructions as to the storage, commissioning, installation, use and maintenance of the Goods or (if there are none) good trade practice; or
- 6.2.3 the Customer alters or repairs such Goods without the written consent of the Supplier; or
- 6.2.4 the defect arises as a result of fair wear and tear, wilful damage, negligence, or abnormal storage or working conditions.
- 6.3 Except as provided in this clause 6, the Supplier shall have no liability to the Customer in respect of the Goods' failure to comply with any warranty or guarantee relating to the Goods.
- 6.4 These Conditions shall apply to any repaired or replacement Goods supplied by the Supplier.
- 7. TITLE AND RISK**
- 7.1 The risk in the Goods shall pass to the Customer on completion of delivery.
- 7.2 Title to the Goods shall not pass to the Customer until the Supplier has received payment in full (in cash or cleared funds) for:
- 7.2.1 the Goods; and
- 7.2.2 all other sums which are or which become due to the Supplier for sales of the Goods or any other products or services to the Customer.
- 7.3 Until title to the Goods has passed to the Customer, the Customer shall:
- 7.3.1 hold the Goods on a fiduciary basis as the Supplier's bailee;
- 7.3.2 store the Goods separately from all other goods held by the Customer so that they remain readily identifiable as the Supplier's property;
- 7.3.3 not remove, deface or obscure any identifying mark or packaging on or relating to the Goods;
- 7.3.4 maintain the Goods in satisfactory condition and keep them insured against all risks for their full price from the date of delivery;
- 7.3.5 notify the Supplier immediately if it becomes subject to any of the events listed in clause 11.1; and
- 7.3.6 give the Supplier such information relating to the Goods as the Supplier may require from time to time, but the Customer may resell or use the Goods in the ordinary course of its business.
- 7.4 If before title to the Goods passes to the Customer the Customer becomes subject to any of the events listed in clause 11.1, or the Supplier reasonably believes that any such event is about to happen and notifies the Customer accordingly, then, provided that the Goods have not been resold, or irrevocably incorporated into another product, and without limiting any other right or remedy the Supplier may have, the Supplier may at any time require the Customer to deliver up the Goods and, if the Customer fails to do so promptly, enter any premises of the Customer or of any third party where the Goods are stored in order to recover them.
- 8. PRICE AND PAYMENT**
- 8.1 The price of the Goods shall be the price set out in the Order, or, if no price is quoted, the price set out in the Supplier's published price list in force and set out in the Supplier's catalogue or on the Supplier's website as at the date of delivery of the Goods.
- 8.2 The Supplier's price list, catalogue or website contains a number of goods which the Supplier can supply to the Customer and it is always possible that, despite the Supplier's best efforts, some of the goods set out on our price list, catalogue or website may be incorrectly priced. If goods are incorrectly priced the Customer will have the opportunity to decline or accept the revised price at the time of placing an Order.
- 8.3 If the pricing error is obvious and unmistakable and could have reasonably been recognised by the Customer as an error the Supplier is under no obligation to provide the Goods to the Customer at the incorrect price.
- 8.4 Notwithstanding the provisions of clauses 8.1 to 8.3 (inclusive), the Supplier may, by giving notice to the Customer at any time before delivery, increase the price of the Goods to reflect any increase in the cost of the Goods that is due to:
- 8.4.1 any factor beyond the Supplier's control (including foreign exchange fluctuations, increases in taxes and duties, and increases in labour, materials and other manufacturing costs);
- 8.4.2 any request by the Customer to change the delivery date(s), quantities or types of Goods ordered; or
- 8.4.3 any delay caused by any instructions of the Customer or failure of the Customer to give the Supplier adequate or accurate information or instructions.
- 8.5 The price of the Goods is exclusive of the costs and charges of packaging, insurance and transport of the Goods, which shall be paid by the Customer when it pays for the Goods. Details of the costs and charges for transport are set out in the Supplier's catalogue in force at the date of delivery of the Goods.
- 8.6 Transport charges for overseas delivery of Goods purchased via the Supplier's website at www.killgerm.com may differ from those charges displayed in the Customer's shopping cart on the Supplier's website and the Customer accepts the higher of those charges will apply. Value added tax (VAT) or its equivalent will be charged at the applicable rate.
- 8.7 Subject to clause 8.10, the price of the Goods is exclusive of amounts in respect of VAT. The Customer shall, on receipt of a valid VAT invoice from the Supplier, pay to the Supplier such additional amounts in respect of VAT as are chargeable on the supply of the Goods.
- Non-account Customers**
- 8.8 If a Customer does not have a pre-approved credit account with the Supplier payment for the Goods is due from the Customer and shall be made by the Customer at the time of the Customer placing an Order.
- 8.9 In the event that payment for the Goods is not made by the Customer at the time of placing an Order and the Customer is not purchasing on a preapproved credit account with the Supplier in accordance with these Conditions, the Supplier shall not be obliged to process the Order and/or deliver the Goods until such payment has been made to the Supplier. Time of payment shall be of the essence to the Contract.
- 8.10 On payment for the Goods in accordance with clause 8.8 or 8.9, the Supplier shall issue a valid receipted VAT invoice to the Customer in respect of the price of the Goods.
- Account Customers**
- 8.11 The Supplier may invoice the Customer for the Goods on or at any time after the Customer places an Order with the Supplier.
- 8.12 Customers with a pre-approved credit account with the Supplier shall pay the invoice in full and in cleared funds on or before the 20th day of the month following the month in which the invoice was dated. Payment shall be made to the bank account nominated in writing by the Supplier, or by the Customer's credit or debit card. Time is of the essence in relation to payments arising under the Contract.
- 8.13 The Supplier shall be entitled to cancel or suspend deliveries under the Contract and/or any other contract, which the Supplier may have with the Customer, if full payment is not made by the Customer, and if such payment or any part of it (including interest) shall remain in arrears for 5 Business Days after a written demand from the Supplier, the Supplier has the right to cancel the Contract and/or any other contract with the Customer, and in either case without prejudice to any other rights or remedies the Supplier may have.
- 8.14 The Supplier shall have the right, after providing notice to the Customer in writing, to cancel or suspend deliveries under the Contract and/or any other contract with the Customer without giving rise to any claim whatsoever by the Customer (even though the Customer may not be in arrears with any payment) where the Supplier considers the amount owed from the Customer (whether actually due for payment or not) is the limit to which the Supplier is prepared to allow the Customer credit.
- 8.15 If the Customer's account becomes overdue all sums payable to the Supplier under any other contract between the Supplier and the Customer shall become immediately due and payable notwithstanding the terms for payment stipulated in such other contract.
- 8.16 The Customer shall pay all amounts due under the Contract in full without any deduction or withholding except as required by law and the Customer shall not be entitled to assert any credit, set-off or counterclaim against the Supplier in order to justify withholding payment of any such amount in whole or in part. The Supplier may at any time, without limiting any other rights or remedies it may have, set off any amount owing to it by the customer against any amount payable by the Supplier to the Customer.
- 9. LIMITATION OF LIABILITY - THE CUSTOMER'S ATTENTION IS PARTICULARLY DRAWN TO THIS CONDITION**
- 9.1 This clause 9 sets out the entire financial liability of the Supplier (including any liability for the acts or omissions of its employees, agents, consultants, and subcontractors) to the Customer in respect of:
- 9.1.1 any breach of the Contract, including any deliberate personal repudiatory breach, or any deliberate breach of the Contract by the Supplier, or its employees, agents or subcontractors;
- 9.1.2 any representation, statement or tortious act or omission (including negligence) arising under or in connection with the Contract.
- 9.2 All warranties, conditions and other terms implied by statute or common law are, to the fullest extent permitted by law, excluded from the Contract.
- 9.3 Nothing in these Conditions limits or excludes the liability of the Supplier for the following:
- 9.3.1 death or personal injury resulting from negligence; or
- 9.3.2 any damage or liability incurred by the Customer as a result of fraud or fraudulent misrepresentation by the Supplier; or
- 9.3.3 breach of the terms implied by section 12 of the Sale of Goods Act 1979; or
- 9.3.4 defective products under the Consumer Protection Act 1987.
- 9.4 Subject to clause 9.2 and clause 9.3:
- 9.4.1 the Supplier shall not be liable (whether in contract, tort (including negligence) breach of statutory duty, or otherwise) for:
- 9.4.1.1 loss of profits; or
- 9.4.1.2 loss of business; or
- 9.4.1.3 depletion of goodwill and/or similar losses; or
- 9.4.1.4 loss of anticipated savings; or
- 9.4.1.5 loss of goods; or
- 9.4.1.6 loss of contract; or
- 9.4.1.7 loss of use; or
- 9.4.1.8 loss of corruption of data or information; or
- 9.4.1.9 any special, indirect, consequential or pure economic loss, costs, damages, charges or expenses.
- 9.4.2 the Supplier's total liability in contract, tort (including negligence or breach of statutory duty), misrepresentation, restitution or otherwise arising in connection with the performance, or contemplated performance, of the Contract shall be limited to the greater of:
- 9.4.2.1 five thousand Euros (€5000); or
- 9.4.2.2 the price paid for the Goods.
- 10. DATA PROTECTION**
- 10.1 The Customer's name, address and payment record may be submitted to an external credit reference agency to run credit checks. The Supplier's use of the data in this way is entirely lawful. The Supplier has a legitimate interest in this personal data being processed for the purpose of assessing whether to grant credit accounts to the Customer.
- 10.2 All personal data will only be used in accordance with the Supplier's privacy policy. The policy can be found at <https://www.killgerm.com/about-killgerm/privacy-policy>. This policy may be updated from time to time and does not form part of this contract.
- 10.3 Information regarding the processing of the Customer's personal data and their associated rights can be found within the privacy policy referred to at clause 10.2 above.
- 10.4 Where the Supplier is processing personal data the Supplier will ensure that it has in place appropriate technical and contractual measures to ensure the security of the personal data and will guard against unauthorised or unlawful processing of the personal data and against accidental loss or destruction of, or damage to, the personal data.
- 11. TERMINATION**
- 11.1 Without prejudice to any other rights or remedies which the Supplier may have, the Supplier may terminate a Contract without liability immediately on giving written notice to the Customer if:
- 11.1.1 the Customer fails to pay any amount due under the Contract on the due date for payment and remains in default not less than 5 Business Days after being notified in writing to make such payment; or
- 11.1.2 the Customer commits a material breach of any of the terms of the Contract and (if such a breach is remediable) fails to remedy that breach within 20 Business Days of that party being notified in writing of the breach; or
- 11.1.3 the Customer commences negotiations with all or any class of its creditors with a view to rescheduling any of its debts, or makes a proposal for or enters into any compromise or arrangement with its creditors other than (where the Customer is a company) these events take place for the sole purpose of a scheme for a solvent amalgamation of the Customer with one or more other companies or the solvent reconstruction of the Customer; or
- 11.1.4 (being an individual) the Customer is the subject of a bankruptcy petition or order; or

- 11.1.5 a creditor or encumbrancer of the Customer attaches or takes possession of, or a distress, execution, sequestration or other such process is levied or enforced on or sued against, the whole or any part of its assets and such attachment or process is not discharged within 14 days; or
- 11.1.6 (being a company) an application is made to court, or an order is made, for the appointment of an administrator or if a notice of intention to appoint an administrator is given or if an administrator is appointed over the Customer; or
- 11.1.7 (being a company) a floating charge holder over the assets of the Customer has become entitled to appoint or has appointed an administrative receiver; or
- 11.1.8 a person becomes entitled to appoint a receiver over the assets of the Customer or a receiver is appointed over the assets of the Customer; or
- 11.1.9 any event occurs, or proceeding is taken, with respect to the Customer in any jurisdiction to which it is subject that has an effect equivalent or similar to any of the events mentioned in clause 11.1.1 to clause 11.1.8 (inclusive); or
- 11.1.10 the Customer suspends, threatens to suspend, ceases or threatens to cease to carry on all or substantially the whole of its business; or
- 11.1.11 the financial position of the Customer deteriorates to such an extent that in the opinion of the Supplier the capability of the Customer adequately to fulfil its obligations under the Contract has been placed in jeopardy; or
- 11.1.12 (being an individual) the Customer dies or, by reason of illness or incapacity (whether mental or physical), is incapable of managing his or her own affairs or becomes a patient under any mental health legislation.
- 11.1.13 there is a change of control of the Customer (as defined in section 574 of the Capital Allowances Act 2001).
- 11.2 For the purposes of clause 11.1.2 material breach means a breach (including an anticipatory breach) that is serious in the widest sense of having a serious effect on the benefit which the Supplier would otherwise derive from a substantial portion of this agreement over the term of any Contract. In deciding whether any breach is material no regard shall be had to whether it occurs by some accident, mishap, mistake or misunderstanding.
- 11.3 On termination of a Contract for any reason:
 - 11.3.1 the Supplier may cancel or suspend all further deliveries of the Goods under the Contract or under any other contract between the Customer and the Supplier without incurring any liability to the Customer;
 - 11.3.2 the Customer shall immediately pay to the Supplier all of the Supplier's outstanding unpaid invoices and interest and, in respect of the Goods supplied but for which no invoice has been submitted, the Supplier may submit an invoice, which shall be payable immediately on receipt; and
 - 11.3.3 the accrued rights and liabilities of the parties as at termination and the continuation of any provision expressly stated to survive or implicitly surviving termination shall not be affected.
- 11.4 On termination of the Contract (however arising), the following clauses shall survive and continue in full force and effect:
 - 11.4.1 clause 1;
 - 11.4.2 clause 9;
 - 11.4.3 clause 11;
 - 11.4.4 clause 12;
 - 11.4.5 clause 13;
 - 11.4.6 clause 14;
 - 11.4.7 clause 15;
 - 11.4.8 clause 16;
 - 11.4.9 clause 18;
 - 11.4.10 clause 20; and
 - 11.4.11 clause 21.

12 INTELLECTUAL PROPERTY RIGHTS

Any Intellectual Property Rights of the Supplier provided to the Customer (including within any Document) shall, at all times, be and remain the exclusive property of the Supplier, but shall be held by the Customer in safe custody at its own risk and shall not be licensed, disposed of or otherwise used except in accordance with the Supplier's written instructions or authorisation.

13 FORCE MAJEURE

- 13.1 Neither party shall be liable for any failure or delay in performing its obligations under the Contract to the extent that such failure or delay is caused by a Force Majeure Event. A Force Majeure Event means any event beyond a party's reasonable control, which by its nature could not have been foreseen, or, if it could have been foreseen, was unavoidable, including strikes, lock-outs or other industrial disputes (whether involving its own workforce or a third party's), failure of energy sources or transport network, acts of God, war, terrorism, riot, civil commotion, interference by civil or military authorities, national or international calamity, armed conflict, malicious damage, breakdown of plant or machinery, nuclear, chemical or biological contamination, sonic boom, explosions, collapse of building structures, fires, floods, storms, earthquakes, loss at sea, epidemics, pandemic or similar events, natural disasters or extreme adverse weather conditions, or default of suppliers or subcontractors, including the default of any carrier engaged by the Supplier in delivering the Goods.
- 13.2 In the event of a Force Majeure Event resulting directly or indirectly in interfering with the means of production or transit of either raw or finished materials or otherwise affects the performance of the Contract by the Supplier the delivery of the Goods sold under the Contract or the performance of any other obligation on the part of the Supplier may be wholly or partially suspended by the Supplier who shall be entitled to be paid forthwith by the Customer for all service provided and Goods supplied up to the time of suspension or abandonment of the work.

14 WRITTEN COMMUNICATIONS

Applicable laws require that some of the information or communication the Supplier sends to the Customer the Supplier should be in writing. When using the Supplier's website, the Customer accepts that communication with the Supplier will be mainly electronic. The Supplier will contact the Customer by e-mail or provide the Customer with this electronic means of communication and acknowledges that all contracts, notices, information and other communications that the Supplier provides to the Customer electronically comply with any legal requirement that such communications be in writing. This condition does not affect the Customer's statutory rights.

15 NOTICES

- 15.1 Any notice or other communication given to a party under or in connection with the Contract shall be in writing, addressed to that party at its registered office (if it is a company) or its principal place of business (in any other case) or such other address as that party may have specified to the other party in writing in accordance with this clause, and shall be delivered personally, sent by pre-paid first-class post, recorded delivery, commercial courier, fax or e-mail.
- 15.2 A notice or other communication shall be deemed to have been received: if delivered personally, when left at the address referred to in clause 15.1; if sent by pre-paid first-class post or recorded delivery, at 9.00 am on the second Business Day after posting; if delivered by commercial courier, on the date and at the time that the courier's delivery receipt is signed; or, if sent by fax or e-mail, one Business Day after transmission.
- 15.3 The provisions of this clause shall not apply to the service of any proceedings or other documents in any legal action.

16 SEVERANCE

- 16.1 If any court or competent authority finds that any provision of the Contract (or part of any provision) is invalid, illegal or unenforceable, that provision or part-provision shall, to the extent required, be deemed to be deleted, and the validity and enforceability of the other provisions of the Contract shall not be affected.
- 16.2 If any invalid, unenforceable or illegal provision of the Contract would be valid, enforceable and legal if some part of it were deleted, the provision shall apply with the minimum modification necessary to make it legal, valid and enforceable.

17 VARIATION

- 17.1 The Supplier may, from time to time and without notice, change the Goods in order to comply with any applicable safety or statutory requirements, provided that such changes do not materially affect the nature, scope of, or the charges for the Services. If the Supplier requests a change to the scope of the Goods for any other reason, the Customer shall not unreasonably withhold or delay consent to it.
- 17.2 The Supplier reserves the right to revise and amend these Conditions from time to time for reasons including changes in market conditions affecting the Supplier's business, changes in technology, changes in payment methods, changes in relevant laws and regulatory requirements and changes in the Supplier's capabilities.
- 17.3 The Customer will be subject to the Conditions in force at the time that it places an Order, unless any change to the Conditions is required to be made by law or governmental authority (in which case it will apply to Orders previously place by the Customer), or, if the Supplier notifies the Customer of the changes to the Conditions before the Supplier accepts the Order in accordance with clause 3.4 (in which case the Supplier has the right to assume that the Customer has accepted the change to the Conditions, unless the Customer notifies the Supplier to the contrary within 5 Business Days of receipt by the Customer of the Goods).
- 17.4 Subject to clauses 17.1 to 17.3 (inclusive), no variation of the Contract or these Conditions or of any of the documents referred to in them shall be valid unless it is in writing and signed by or on behalf of each of the parties.

18 WAIVER

- 18.1 A waiver of any right under the Contract is only effective if it is in writing and it applies only to the circumstances for which it is given. No failure or delay by a party in exercising any right or remedy under the Contract or by law shall constitute a waiver of that (or any other) right or remedy, nor preclude or restrict its further exercise. No single or partial exercise of such right or remedy shall preclude or restrict the further exercise of that (or any other) right or remedy.
- 18.2 Unless specifically provided otherwise, rights arising under the Contract are cumulative and do not exclude rights provided by law.

19 ASSIGNMENT

- 19.1 The Customer shall not, without the prior written consent of the Supplier, assign, transfer, charge, mortgage, subcontract, declare a trust of or deal in any other manner with all or any of its rights or obligations under the Contract.
- 19.2 The Supplier may at any time assign, transfer, charge, mortgage, subcontract, declare a trust of or deal in any other manner with all or any of its rights under the Contract and may subcontract or delegate in any manner any or all of its obligations under the Contract to any third party or agent.
- 19.3 Each party that has rights under the Contract is acting on its own behalf and not for the benefit of another person.

20 NO PARTNERSHIP OR AGENCY

Nothing in the Contract is intended to, or shall be deemed to, constitute a partnership or joint venture of any kind between any of the parties, nor constitute any party the agent of another party for any purpose. No party shall have authority to act as agent for, or to bind, the other party in any way.

21 RIGHTS OF THIRD PARTIES

A person who is not a party to the Contract shall not have any rights under or in connection with it.

22 GOVERNING LAW AND JURISDICTION

- 22.1 The Contract, and any dispute or claim arising out of or in connection with it or its subject matter or formation (including non-contractual disputes or claims), shall be governed by, and construed in accordance with, the law of Republic of Ireland.
- 22.2 The parties irrevocably agree that the courts of England and Wales shall have exclusive jurisdiction to settle any dispute or claim that arises out of, or in connection with, the Contract or its subject matter or formation (including non-contractual disputes or claims).

23 DISPUTE RESOLUTION

- 23.1 The Supplier and Customer shall attempt in good faith to negotiate a settlement to any dispute between them arising out of or in connection with this agreement within 10 Business Days of either party notifying the other of the dispute such efforts shall involve the escalation of the dispute to the finance director of the Supplier.

- 23.2 Nothing in this dispute resolution procedure shall prevent the parties from seeking from any court of the competent jurisdiction an interim order restraining the other party from doing any act or compelling the other party to do any act
- 23.3 If the dispute cannot be resolved by the parties any dispute over €5,000 shall be referred to mediation pursuant to the procedure set out in this clause unless the Supplier considers that the dispute is not suitable for resolution by mediation.
- 23.4 The performance of the Contract shall not be suspended, cease or be delayed by the reference of a dispute to mediation and the Customer shall comply fully with the requirements of this agreement at all times.
- 23.5 The procedure for mediation and consequential provisions relating to mediation are as follows:
 - 23.5.1 a neutral adviser or mediator ("the Mediator") shall be chosen by the Supplier within 10 business days after a request by one party to the other
 - 23.5.2 Unless otherwise agreed, all negotiations connected with the dispute and any settlement agreement relating to it shall be conducted in confidence and without prejudice to the rights of the parties in any future proceedings.
 - 23.5.3 If the parties reach agreement on the resolution of the dispute, the agreement shall be reduced to writing and shall be binding on the parties once it is signed by their duly authorised representatives.
 - 23.5.4 Failing agreement, either of the parties may invite the Mediator to provide a non-binding but informative opinion in writing. Such an opinion shall be provided on a without prejudice basis and shall not be used in evidence in any proceedings relating to the agreement without the prior written consent of both parties.
 - 23.5.5 If the parties fail to reach agreement in the structured negotiations within 60 Business Days of the Mediator being appointed, or such longer period as may be agreed by the parties, then any dispute or difference between them may be referred to the Courts.

Killgerm Ireland Limited
Unit B2 Centre Point,
Rosemount Business Park,
Dublin 11, D11 HP52

A	
Adhesives	144
Advion Ant Gel	15
Advion Cockroach Gel	16
Aerosol Nozzle Kit	17
Aerosols	17
AF Advance Mouse Box	84
AF Amicus	88
AF Atom	90
AF Demi-Diamond	23
AF Ephestia/Plodia Pads	23
AF Fortis	89
AF Fruit Fly Trap	27
AF Insect Bracket	22
AF Insect Monitoring System	22
AF Insect Pads	22
AF Mouse Box Accessories	83
AF Multis Trapping Station	97
AF Pinpoint	15
AF Powder Scoop	11
AF Rat Box Accessories	91
AF Rat Box	90
AF Rodent Cone	111
AF Snappa	82
AF Standard Inspector	66
AF Telescopic Bait Rod	71
AF Tineola Bisselliella Pads	23
AF Trolley	69
AF Tunnel	92
AF Tyre Baiter	93
AF Underground	93
AF Wasp and Fly Bait	19
AF Wasp and Fly Trap	19
Alphachloralose	76
Aluminium Mouse Proofing Grilles	110
Ant Gels	15
Aquapy	13
AR Bulb Duster	51

AR3 Pro Kit	52
AR8 Pro Kit	52
Avipoint	134
Avishock Electric System	136
B	
Bacon Rat & Mouse Lure	99
Bags, Pesticide	69
Bait Bags (Rodent)	106
Bait Box Pads	96
Bait Guns	16
Bait Station Anchor	96
Bait Station Warning Stickers	104
Bait Trays	96
Batteries	70
Bayer/Envu Flying Insect Aerosols	17
Bed Bug Life Cycles	29
Bed Bug Products	28
Beekeepers All-In-One Suit	65
Beekeepers Clothing Hold All	65
Beekeepers Gloves	64
Beekeepers Hat & Veil	64
Beekeepers Jackets	64
Beekeepers Trousers	64
Bird Despatcher	143
Bird Fixings	123
Bird Free Stiq	119
Bird Free	118
Bird Netting	122
Bird Spikes	134
Birdwire Systems	126
Black Cat Nano	98
Black Cat Rat Trap	98
Black Pearl	76
Black Stripe Moth Trap	24
Boards (EFK's)	39
Bristle Strip	107

Brodifacoum	78
Bromadiolone	77
Bumper Seal	108
C	
Cage Traps	114
Camera Equipment	66
Cardboard Bait Boxes	84
Carry Bag	63
Cartridge Cutter	70
Cat Grabbers	115
Cat Traps	114
Cavity Weep Hole fittings	111
Chameleon EXG	38
Chameleon Qualis	33
Chameleon Range EFK's	34
Chameleon Sirius	36
Chameleon Sticky Boards	39
Chameleon Vega	36
Chemical Storage Units	63
Chemlock Storage Boxes	63
Chimney Pot Spike	146
Chimney Spike	146
Cholecalciferol	76
Cifarelli Blower	48
Cimetrol Super EW	10
Cimetrol Super RFU	10
Cimex Eradicator	28
Climb Up	29
Clip Box Mouse Trap	85
Coast LED/UV Torch	73
Cockroach Gels	16
Cockroach Traps	25
Contrac All Weather Blox	77
Coopex Maxi Smoke Generator	14
Coopex Mini Smoke Generator	14
Coumatetralyl	76

Coveralls, Tyvek 600 Plus	96
Crystal Adhesive	144
D	
Daddi Long Legs	145
Deadline Odourising Sachets	106
Deadline Pyfog	14
Deadline Pyspray	14
Decoy Birds	147
Demi-Diamond Trap	23
Deodorant	106
Detex Blox	79
Diagrams	84
Diatomaceous Earth	11
Difenacoum	77
Digital Monitoring	102
Digrain Wasp & Hornet Destroyer	18
Disinfectants	149
Dismate PE	21
Disposable Fly Bags	26
Disposable Wasp Bags	20
Dog Graspers	115
Dog Trap	115
Dome Fly And Wasp Trap	19
DR5 Duster	50
DR5 Mini Flex Tip	50
Drill	71
Dusters	50
Dye, Drain Testing	117
E	
Electronic Bird System	136
Electronic Fly Killers	31
Electrostatic Sprayers	47
Exodus Carry Bag	45
Exodus ULV Machine	45
Expanding Foam	112
Extension Lances	51

F	
Face Masks	58
Fenn Trap MK4	98
Fenn Trap MK6	114
Ferrules	126
Ficam D	11
Filters, Respirators	59
First Aid Kits	61
Fixall Crystal Adhesive	144
Flea Trap	20
Flexible Bristle Strip	108
Flexible Net Frame	128
Flexible Proofing Mesh	109
Fluorescent Tracking Dust	80
Fly Bag	26
Fly Traps	26
flyDetect®	40
Flying Falcon	147
Flykiller Tubes	42
Flykillers, Electric	31
Flypapers	27
Foam	112
Foggers	48
Fox Trap	115
Fruit Fly Traps	27
Full Face Respirators	58
Funnel Liners	24
G	
Gel Fluorescent Tracking	80
Gels	15
Gloria No.89 1 Litre Sprayer	47
Gloria Pneumatic Sprayers	46
Gloria Pressure Regulators	46
Gloves	61
Gold Stick Fly Traps	27
Goodnature A18 Squirrel Trap	113

Goodnature A24 Rat Trap	100
Gorilla Wipes	62
Grey Squirrel Bait	113
Grid Tester	43
Gull Eggs	145
Gun Pellets	148
H	
Hand Sanitiser	62
Hand Wipes	62
Harmonix Monitoring Paste	79
Harmonix Poultry Red Mite	11
Hawk Kite	147
Hidden Kill Mouse Trap	85
Hog Rings	127
Hoy Hoy Trap-A-Roach	25
I	
Ice Spray	17
IK9 Sprayer	20
Insect Bait Stations	15
Insect Monitors	22
Insect Sample Pots	68
Insect Viewer	68
Inspection Equipment	66
K	
Klerat	78
K-Obiol EC25	11
K-Othrine Partix	10
L	
Labels/Stickers	104
LED Fly Killers	33
LED Hand Lens	68
LED Torches	73
Litter Picker	68
Locating Paddle	113
Lureking No12 Traps	25
Lureking No30 Traps	25

M					
Manhole Lifting Key	117	PestWest Machines	31	Ratimor Difenacoum Fresh Bait	78
Mating Disruption System	21	Pheromone Dispensers	24	RatMat	101
Maxforce Platin	16	Phobi F&F One Shot	18	Raxit Doorseal Roll	108
Maxforce Quantum	15	Pigeon Traps	143	Red Top Fly Catcher	27
Metal Rat Boxes	87	Pinpoint Insect Bait Station	15	Repellents	106
Mink Trap	114	Pitfall Trap	26	Report Pads A4/A5	71
Monitoring Bait	79	Plastic Bait Gun	16	Respirators	60
Monitoring Traps, various	24	Plastic Gull Eggs	145	Rifle Accessories	148
Moth Traps	24	Powder Scoop	11	Rinse Kit	71
Motion Sensor Camera	67	PPE Plastic Carry Case	58	Rodent Bait Bags	106
Mouse Boxes	84	Pressure Regulators	46	Rodent Brush	109
Mouse Mesh Vents	110	Prickler Strips	145	Rodent Cone	111
Mouse Traps	85	Proofing	107	Rodent Deodorant	106
Mousestop	112	Protecta Ambush	95	Rodent Warning Signs	104
N		Protecta Landscape	95	Rodenticides	76
Nano Black Cat Rat Trap	98	Protecta LP	95	Rollerseal	108
Nemesis Quattro	32	Protecta Rat Bait Station	95	Roof Mounts	131
Nets	122	Protecta Tunnel	95	S	
Nilaqua Hand Sanitiser	62	Provecta	10	Sakarar Brodifacoum Gel	78
Nippon Ant Gel	15	Provoke (Mice)	86	Sakarar Brodikill	79
Nitrile Gloves	61	Provoke (Rats)	99	Sakarar Bromabait	77
No. 7 Mouse Bait Station	84	PX-Ornikill	149	Sakarar D Wax Bait	77
No.4 Cardboard Bait Boxes	84	Pybuthrin 33	13	Sakarar Fluorescent Tracking Gel	80
Non-toxic Bait	79	Pyfog	13	Sakarar Monitoring Bait	79
NSS Brackets	132	Pyspray	13	Sakarar Rodent Barrier	112
O		Q		Sakarar Rodent Stop	112
Odour Remover Bags	106	Qualis	33	Sample Pots	68
On-Top Pro	36	Quantum Tubes	42	Scoot Fox Repellant	106
Owls	147	R		Screws	128
P		Rabbit Traps	114	Selontra	76
Pellets	148	Rabies Gloves	115	Semark Dispatcher	143
Pest Dual	63	Racumin Foam	76	Sensci Pyramid	28
Pest Partner	63	Rat Boxes	94	Sensor Camera	67
Pesticide Carry Bag	63	Rat Flap Non-Return Valves	116	Sentinel Jacket	65
Pesticide Jars	63	Rat Tape	108	Silvercheck Trap	25
		Rat Traps	98	Smokes	14

Snap Traps	85
Snap-E Mouse Trap	85
Snap-E Rat Trap	98
Solar Mesh	146
Solar Panel Clips	146
Solar Panel Spikes	146
Spare Parts Diagrams	52
Sparrow Spikes	146
Spectrum Lures	24
Sprayers, various	46
Squirrel Bracket	113
Squirrel Traps	114
Starters	43
Steam Kit	28
Stickers/Labels	104
Sticky Boards (Flykillers)	39
Sticky Flypapers	27
Storage Devices	63
Sunburst Tab	37
Sunburst	37
Sundstrom Filters	59
Sundstrom Masks	58
Superflow Sealant Gun	144
Super-H-Point Pellets	148
T	
T8D Extension	50
T8S Liquid Spraying	49
Talon Paste	78
TC7 Camera	67
Tech Reach Bait Extension	16
Telescopic Bait Rod	71
Tineola Pads	23
Titan 200 IP	39
Titan 300	33
Titan Alpha	33
Torches	73

Touch n Tuff Gloves	61
Tracing Dyes	117
Tracking Dust	80
Tracking Gel	80
Trapper Mini Rex	85
Trapper T-Rex	98
Trays for Bait	96
Tubes, Flykiller	42
Tyre Bait Station	93
U	
ULV 500	13
ULV Equipment	45
Underground Station	93
Unikey Manhole Lifting Kit	117
UV Torch	73
UV Tubes	42
V	
Vazor DE Powder	11
Vazor ICE	17
Vazor Phepra CS	10
Vazor Provecta	10
Vazor ULV 500	13
Vazor Wasp Nest Destroyer Aerosol	18
Vents	110
Video Equipment	67
Vinyl Gloves	61
W	
Wall Plaques	104
Warning Signs	104
Wasp Bag	20
Wasp Nest Destroyer Aerosols	18
Wasp Traps	19
Wax Bait	77
Weep Hole Fittings	111
Wipes	62
Wire Wool	109

Wireless Monitoring	102
Wood Worm Killer	14
X	
Xcluder Mesh	109
Xlure FIT	25
Xlure MST	26
Y	
Yellow Cable Ties	90

You know when
you're in safe hands!

www.killgerm.com

Hazard Information

for Amateur Products

EUH 208: Contains <substance(Permethrin)>. May produce an allergic reaction

EUH401: to avoid risks to human health and the environment, comply with instructions for use

H222: extremely flammable aerosol

H226: flammable liquid and vapour

H225: highly flammable liquid and vapour

H229: pressurised container: may burst if heated

H302: harmful if swallowed

H312: harmful in contact with skin

H314: causes severe skin burns and eye damage

H315: causes skin irritation

H317: may cause an allergic skin reaction

H319: causes serious eye irritation

H332: harmful if inhaled

H336: may cause drowsiness or dizziness

H371: may cause damage to organs

H410: very toxic to aquatic life with long-lasting effects

H411: toxic to aquatic life with long-lasting effects

H412: harmful to aquatic life with long-lasting effects

P102: keep out of reach of children

P103: read label before use

P210 keep away from heat/sparks/open flames/hot surfaces. -no smoking

P211: do not spray on an open flame or other ignition source

P233: keep container tightly closed

P242: use only non-sparking tools

P243: take precautionary measures against static discharge

P251: pressurized container: do not pierce or burn, even after use

P260 do not breath dust/mist/spray/vapours

P261: avoid breathing dust/fume/gas/mist/vapours/spray

P264: wash face, hands and any exposed skin thoroughly after handling

P270: do not eat, drink or smoke when using this product

P272: contaminated work clothing should not be allowed out of the workplace

P273: avoid release to the environment

P280: wear protective gloves and face protection

P301 + P310 if exposed or concerned: call poison center/doctor/physician

P301 + P312: if swallowed: call a poison center or doctor/physician if you feel unwell. rinse mouth

P301 + P330 + P331: if swallowed: rinse mouth. do not induce vomiting

P302 + P352: if on skin: wash with plenty of soap and water

P303 + P361 + P353: if on skin(or hair): take off immediately all contaminated clothing. rinse skin with water/shower

P304 + P340: if inhaled: remove victim to fresh air and keep at rest in a position comfortable for breathing

P305 + P351 + P338: if in eyes: rinse cautiously with water for several minutes. remove contact lenses, if present and easy to do. continue rinsing

P315: get immediate medical advice/attention

P333 + P313: if skin irritation or rash occurs: get medical advice/attention

P337+P313 if eye irritation persists: get medical advice/attention

P351 rinse cautiously with water for several minutes

P362: take off contaminated clothing and wash before reuse

P370 + P378: in case of fire: use water spray to extinguish

P371 + P380 + P375: in case of major fire and large quantities: evacuate area. fight fire remotely due to the risk of explosion

P391: collect spillage

P403: store in a well-ventilated place

P410 + P412: protect from sunlight. do not expose to temperatures exceeding 50°C

P501: dispose of contents/container to a licensed hazardous waste disposal contractor or collection site

Personalised products add a highly professional image to your company's activities.

Also available for corporate printing, No.4 Cardboard Bait Boxes - p137

Corporate printing shows off your organisation to a good advantage. Effectively you have your own product and your details remain visible as an advertisement, encouraging repeat business.

A wider range of our products can now be personalised. Insect monitors, bait stations, and labels can carry your company name and details and, in some cases, your logo as well.

On this page we have gathered together a selection of our most popular personalisable products. Please contact us for further details.



P41
Ecotrap Insect Monitor



P40
AF* Insect Monitoring System



P143
No7 Mouse Bait Station



P142
AF* Discreet Mouse Box



P154
AF* Fortis



P142
AF* Advance Mouse Box



P154
AF* Rat Box



P154
AF* Atom



P154
AF* Tunnel



P154
AF* Multis

Supporting a pest free environment

At Killgerm® we won't let you down, supporting you through legislation changes with new products, training and technical advice, RSPH trained customer service staff, Area Sales Managers & rapid deliveries.

2023
PRODUCT CATALOGUE

Tools & Accessories

Electronic Fly Killers

Information & Guidance

Cleaning & Hygiene

RODENT CONTROL | INSECT CONTROL | APPLICATION EQUIPMENT | HEALTH & SAFETY | BIRD CONTROL

Technical Support | Customer Service | Workshops | High Quality Training
Delivery Services | Waste Disposal Scheme | Marketing | Breakfast Meetings

Ossett Warsaw Gilze Neuss Turnhout Zurich Lisbon Barcelona Malmö Dublin Lyon